

RICAMBI YAMATO

FOR DCZ-200-D2

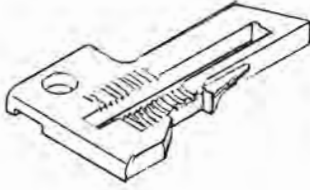

32667
Stitch Plate

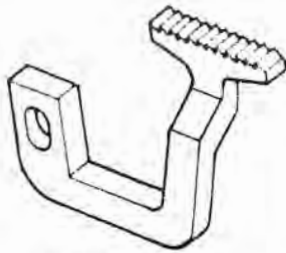

33810
Differential Feed Dog



33811
Main Feed Dog



32883
Auxiliary Feed Dog

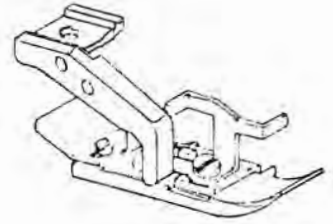

32734
Presser Foot

FOR DCZ-200-D1

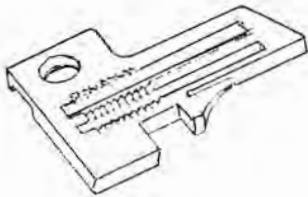

34893
Stitch Plate

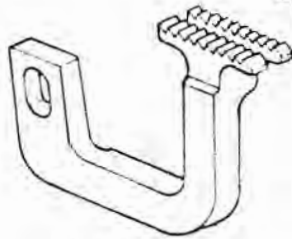

34852
Differential Feed Dog

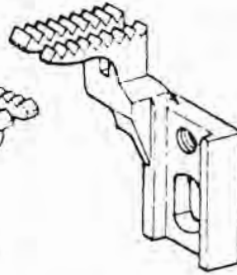

34851
Main Feed Dog



32883
Auxiliary Feed Dog

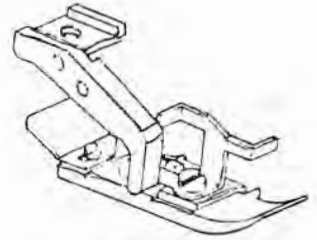

32345
Presser Foot

FOR DCZ-216

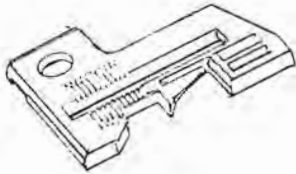

34420
Stitch Plate

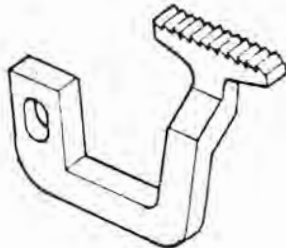

33812
Differential Feed Dog

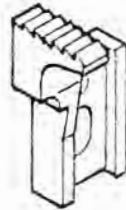

33811
Main Feed Dog



33328
Auxiliary Feed Dog

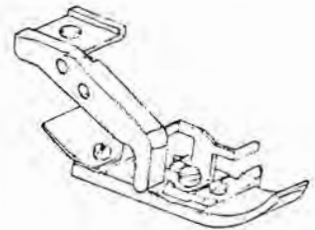

34922
Presser Foot

FOR DCZ-203

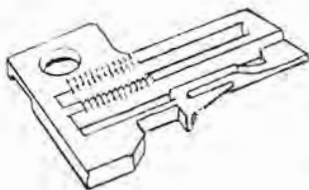

32671
32672
32673
Stitch Plate

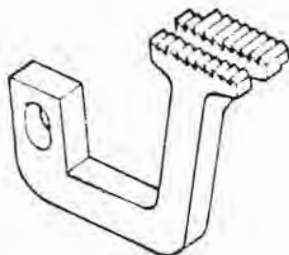

33813
Differential Feed Dog

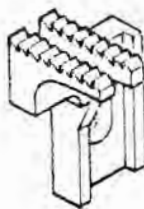

33814
33818
Main Feed Dog

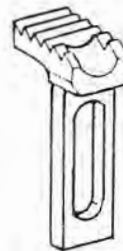

32883
Auxiliary Feed Dog

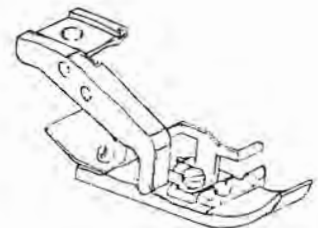

32747
32748
Presser Foot

FOR DCZ-200W-D1

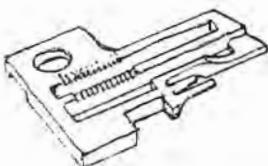

32678
Stitch Plate

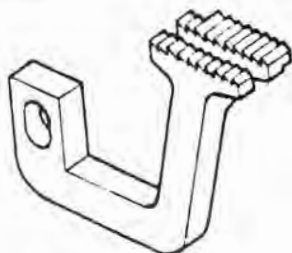

33813
Differential Feed Dog

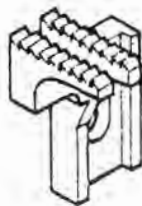

33814
Main Feed Dog



32883
Auxiliary Feed Dog

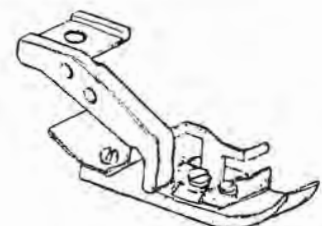

32750
Presser Foot

RICAMBI YAMATO

FOR DCZ-222/223

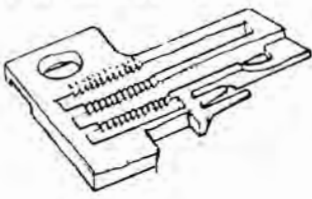

32571
Stitch Plate

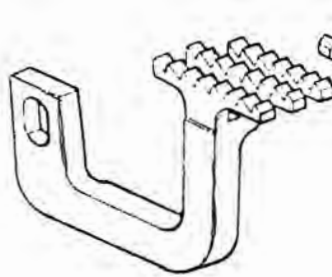

33819
Differential Feed Dog

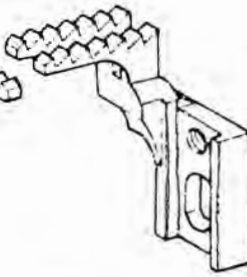

33818
Main Feed Dog



32557
Auxiliary Feed Dog

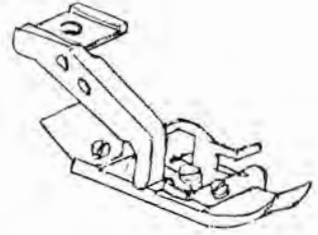

32579
Presser Foot

FOR DCZ-503-D1
-D2

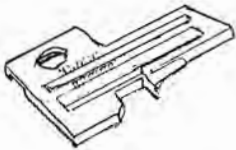

34564
34565
34566
Stitch Plate

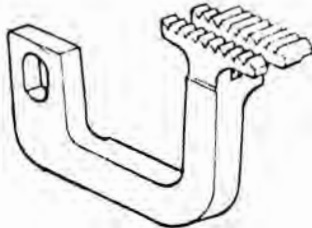

33840
Differential Feed Dog



33814
Main Feed Dog



32883
Auxiliary Feed Dog

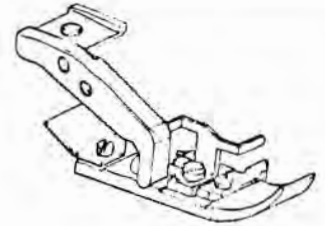

32747
327748
Presser Foot

DCZ-520-D1/520W-D1

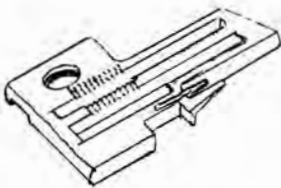

34598 (34585)
34593
Stitch Plate

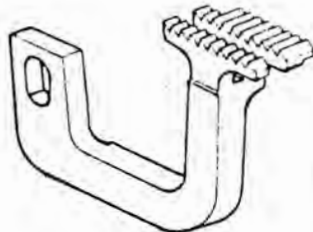

33840
Differential Feed Dog



33814
Main Feed Dog



32883
Auxiliary Feed Dog

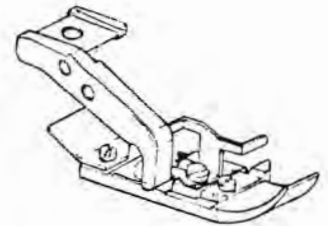

32750
32760
Presser Foot

DCZ-521-D1

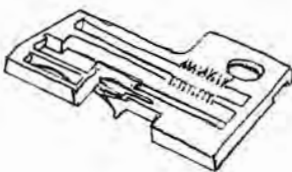

34600
Stitch Plate

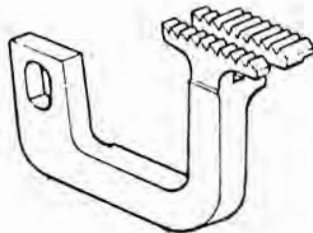

33840
Differential Feed Dog



33814
Main Feed Dog



32341
Auxiliary Feed Dog

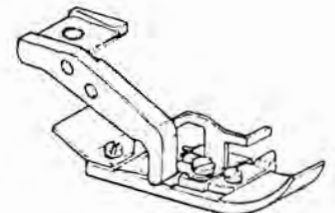

32343
Presser Foot

DCZ-361A/362A

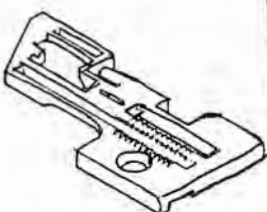

33541
Stitch Plate

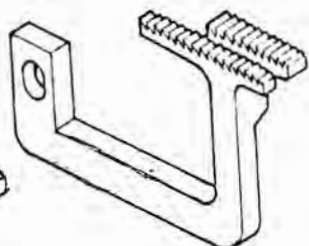

33824
Differential Feed Dog

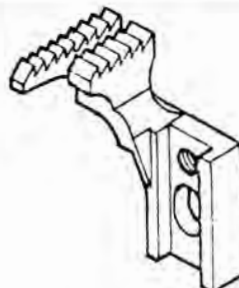

33825
Main Feed Dog



33544
Auxiliary Feed Dog

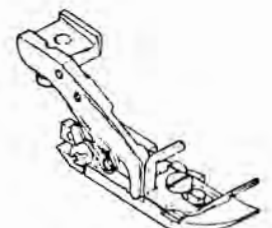

33537
Presser Foot

RICAMBI YAMATO

FOR DCZ-361C/362C

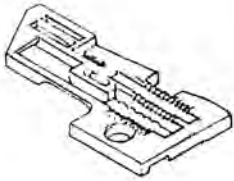

33545
Stitch Plate

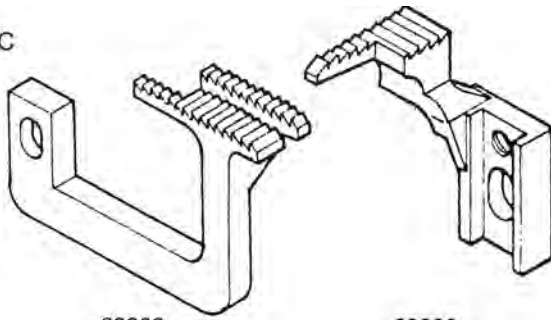

33828
Differential Feed Dog

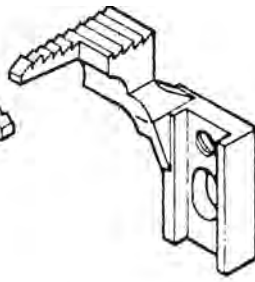

33829
Main Feed Dog



33328
Feed Dog

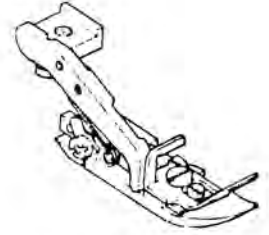

33539
Presser Foot

FOR DCZ-341C-D4

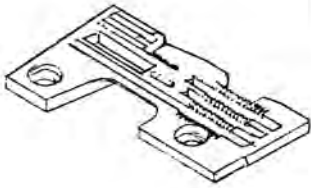

35334
Stitch Plate

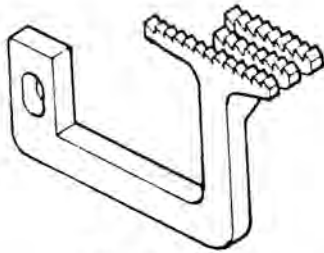

35335
Differential Feed Dog

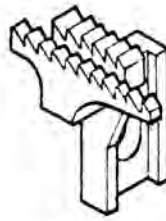

35331
Main Feed Dog



35264
Auxiliary Feed Dog

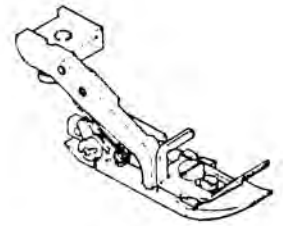

35263
Presser Foot

FOR DCZ-341C-D4-1

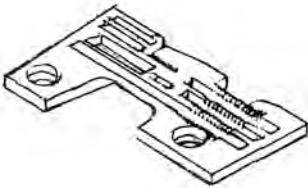

35334
Stitch Plate

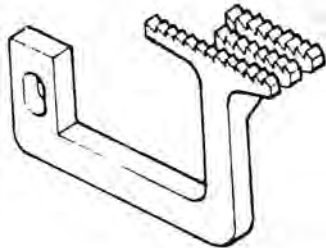

35335
Differential Feed Dog

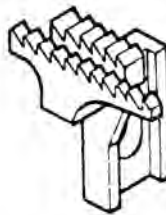

35331
Main Feed Dog



35264
Auxiliary Feed Dog

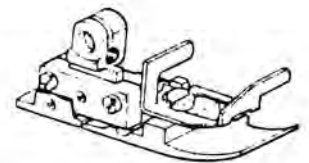

35325
Presser Foot

FOR DCZ-361

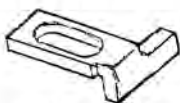

33515
Foot Chip Guard



33304
Foot Hinge Spring

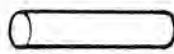

731
Foot Pin



33525
Foot Spring (Large)



33526
Foot Spring (Small)

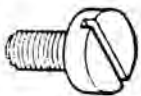

5036
Screw

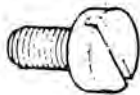

1226
Screw



1228
Screw



216
Nut

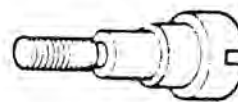

6093
Screw



33529
Presser Foot
Adjusting Plate



4404
Screw



5401
Screw



3637
Screw



3638
Screw



37919
Hexagon Screw Driver



1092
Screw



32706
Chain Cutter



32425
Needle Bar Thread
Retainer Plate

RICAMBI YAMATO



38101
Needle Clamp



33247
Needle Clamp

FOR DCZ-361

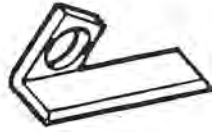

33087
Needle Guard (Front)

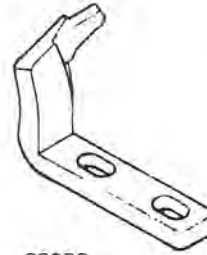

33088
Needle Guard (Rear)

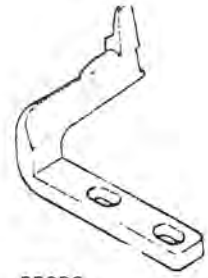

33086
Needle Guard (Rear)

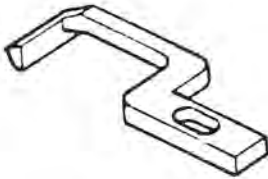

33250
Needle Guard (Front)

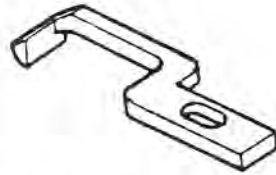

33089
Needle Guard (Front)

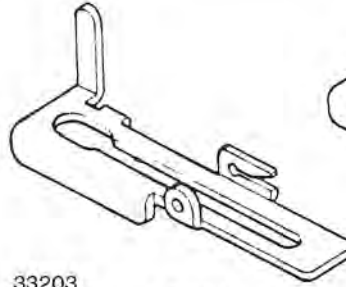

33203
Thread Take-up Eyelet

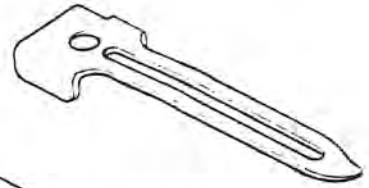

33205
Thread Retaining Finger

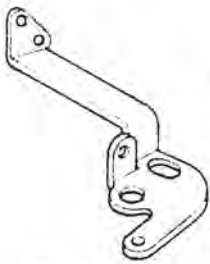

32959
Looper Thread
Pull-off



34224
Looper Thread
Pull-off

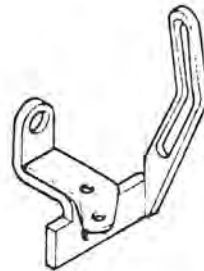

33167
Needle Bar Thread
Retainer Bracket



33081
Double Chaining
Looper Cellar

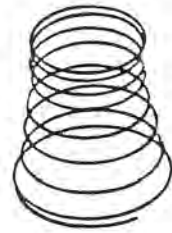

32952
Looper Thread
Tension Spring

FOR Z100-A2

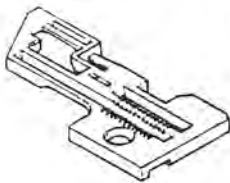

33568
Stitch Plate

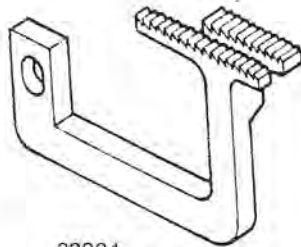

33824
Differential Feed Dog

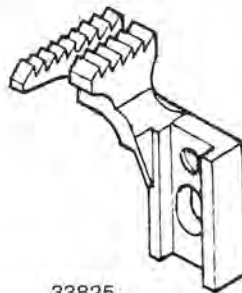

33825
Main Feed Dog



33544
Auxiliary Feed Dog

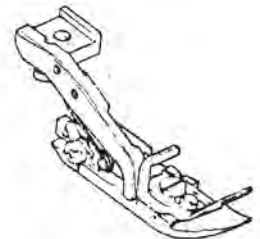

33537
Presser Foot

FOR Z100-C5

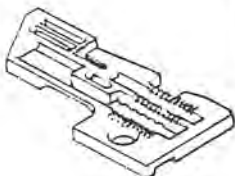

36590
Stitch Plate

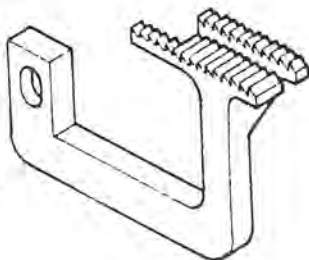

33828
Differential Feed Dog

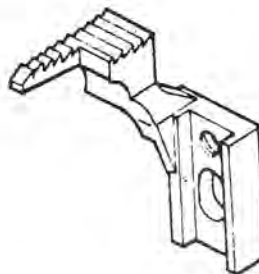

33829
Main Feed Dog



33328
Auxiliary Feed Dog

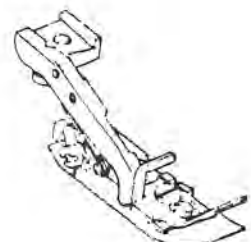

33539
Presser Foot

RICAMBI YAMATO

FOR Z6000-C5

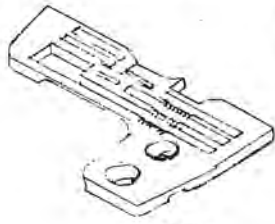

22012
Stitch Plate

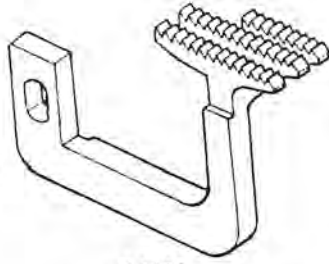

20460
Differential Feed Dog

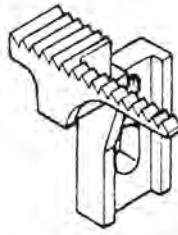

20461
Main Feed Dog



20441
Auxiliary Feed Dog

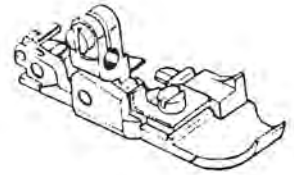

22131
Pressere Foot

FOR Z600-C6

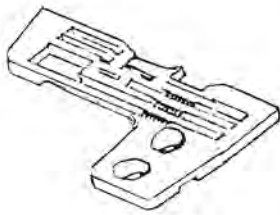

22075
Stitch Plate

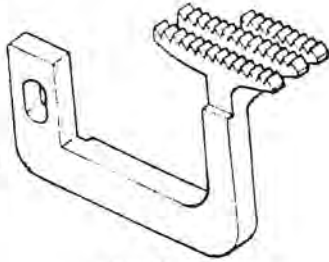

20460
Differential Feed Dog

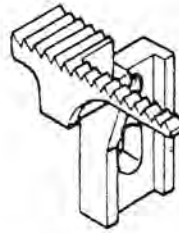

20461
Main Feed Dog



20441
Auxiliary Feed Dog

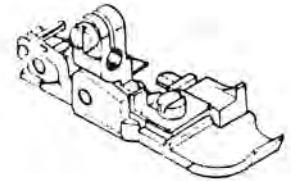

22133
Presser Foot

FOR Z6100-C5/C7

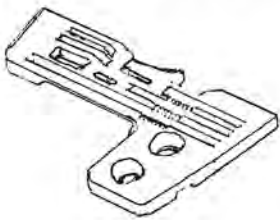

22220
22235
Stitch Plate

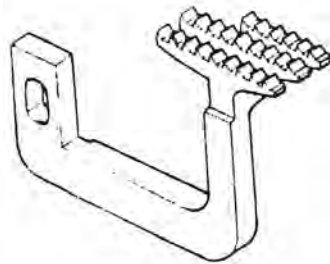

22222
Differential Feed Dog

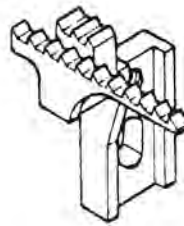

22223
Main Feed Dog



20441
Auxiliary Feed Dog

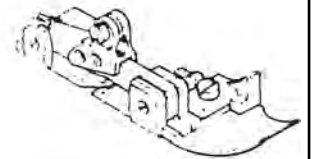

22230
22218
Presser Foot

FOR Z5003-03/04

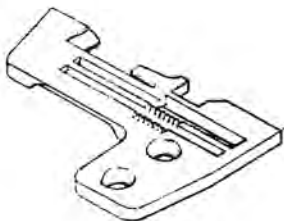

21768
21769
Stitch Plate

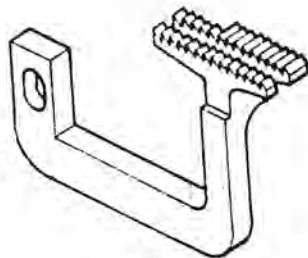

21846
Differential Feed Dog

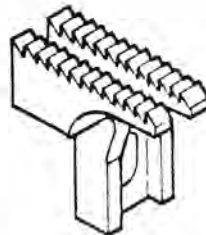

21842
Main Feed Dog



21009
Auxiliary Feed Dog

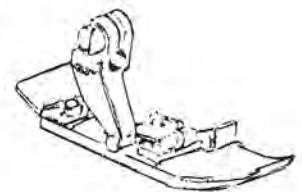

23000
23001
Presser Foot

FOR Z5003-05

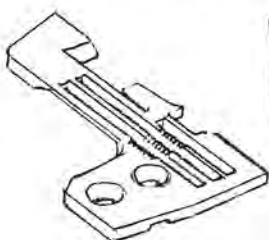

21774
Stitch Plate

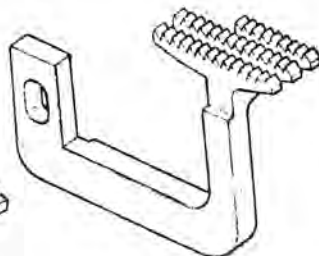

21847
Differential Feed Dog

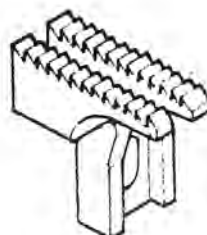

21842
Main Feed Dog



21009
Auxiliary Feed Dog



23002
Presser Foot

RICAMBI YAMATO

FOR Z5020-X4

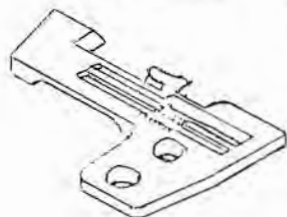

21781
Stitch Plate

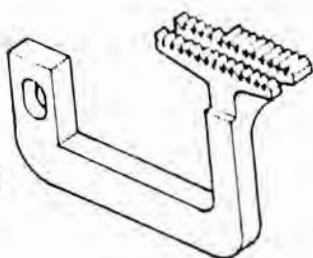

21846
Differential Feed Dog

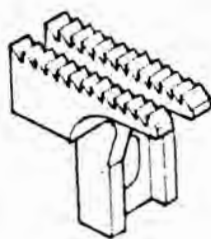

21842
Main Feed Dog



21009
Auxiliary Feed Dog

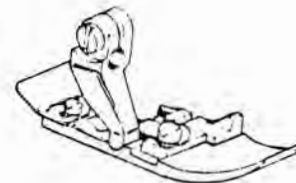

23030
Presser Foot

FOR Z5020-X5

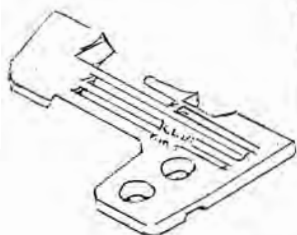

22601
Stitch Plate

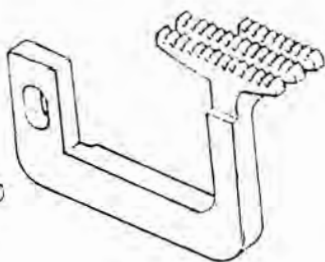

22608
Differential Feed Dog

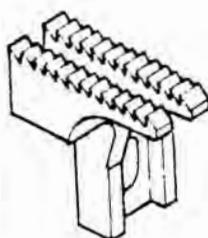

21842
Main Feed Dog



21009
Auxiliary Feed Dog

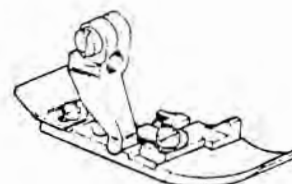

23032
Presser Foot

FOR Z-6000-A3/A4

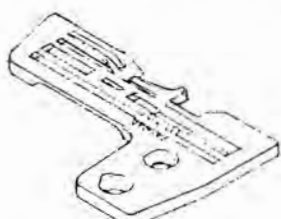

21800
21801
Stitch Plate

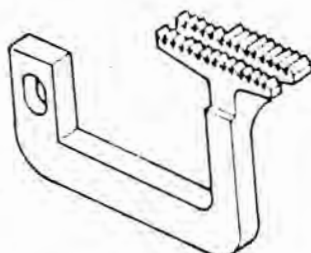

21846
Differential Feed Dog

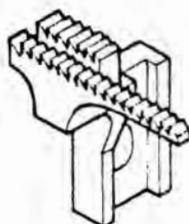

21848
Main Feed Dog



20441
Auxiliary Feed Dog

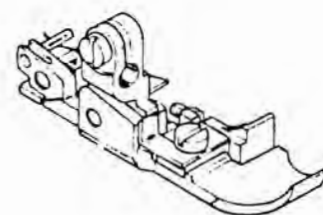

22085
22087
Presser Foot

FOR Z-6000-A5/A6

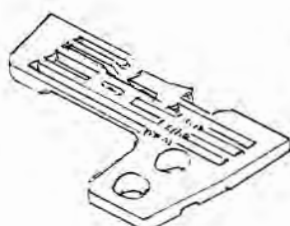

21812
21813
Stitch Plate

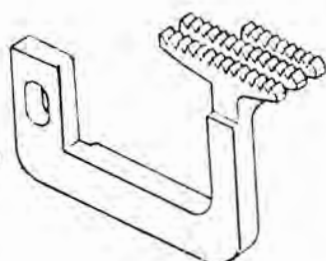

21847
Differential Feed Dog

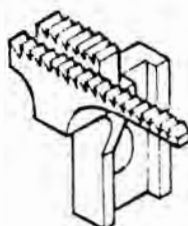

21848
Main Feed Dog



20441
Auxiliary Feed Dog

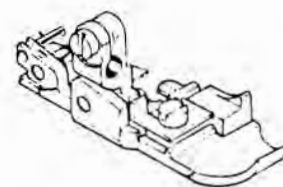

22089
22091
Presser Foot



Y2101133
gruppo rientro
catenella per
YAMATO 8000



Y2121000 tagliacatenella
YAMATO AZF8400

Disponibili inoltre:

Y2109906 (K1) orizzontale
kl. AZ8500 - AZ8600 etc.

Y2109917 (K2) verticale
kl. AZ8300 - 8000 - 6000 - 6003

tirante - bidone - venturi
(vedi a pag. 140)

**RIEPILOGO LOOPERS YAMATO (importazione)
la produzione MAIER è nelle pagine successive**

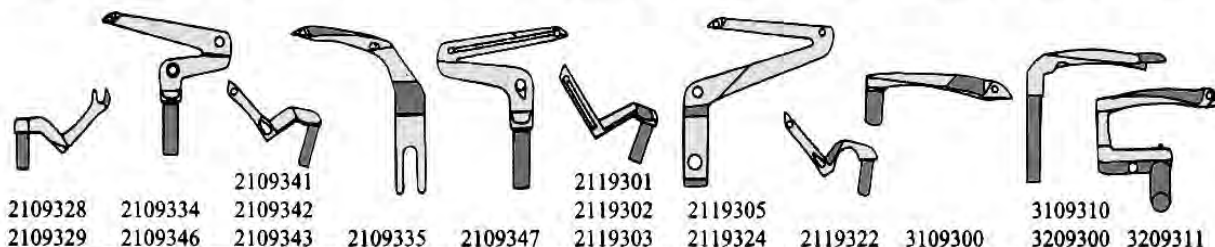
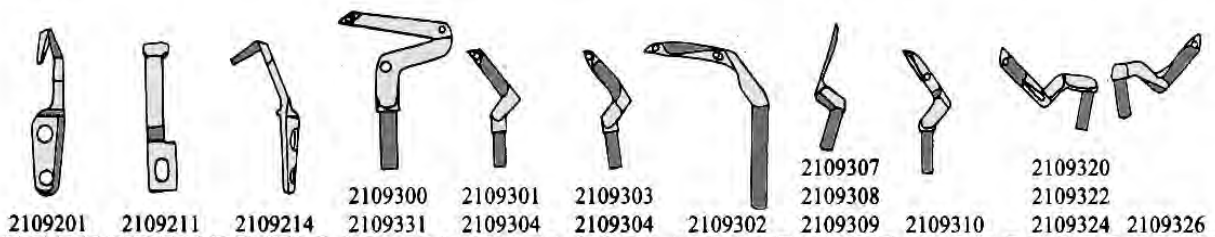
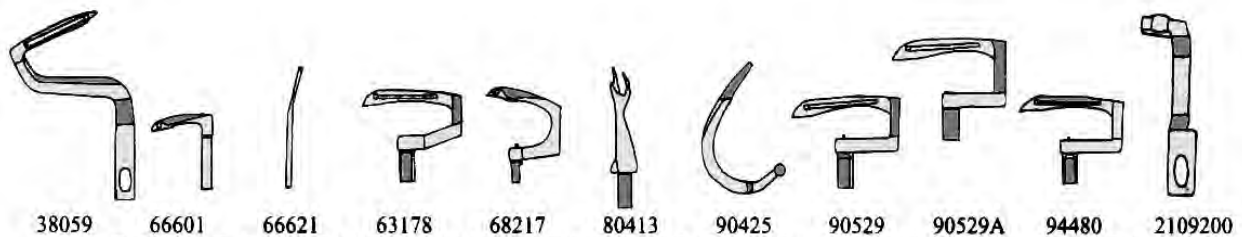
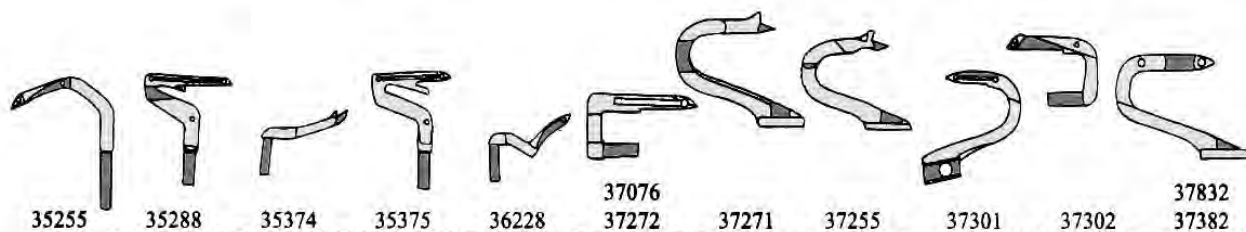
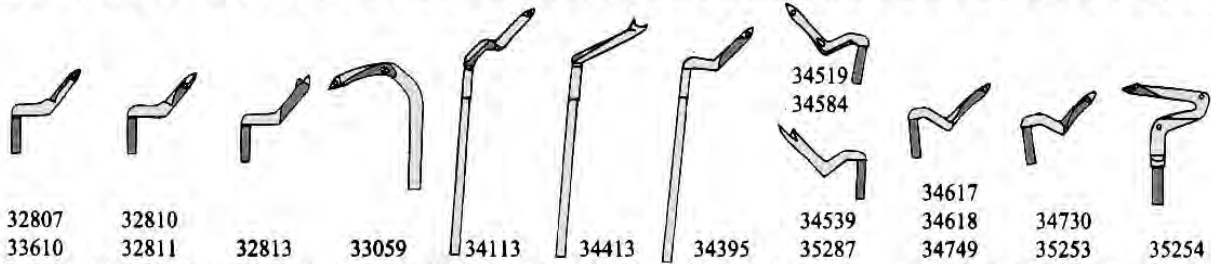

Vi ricordiamo che su richiesta , siamo in grado di fornire anche ricambi originali di tutte le marche principali : in particolare, PFAFF – REECE –AMF STROBEL – MAUSER PEGASUS – JUKI - UNION SPECIAL – UNITAS – SIRUBA – KANSAI con listino ufficiale

RICAMBI YAMATO

"K2" DEVICE

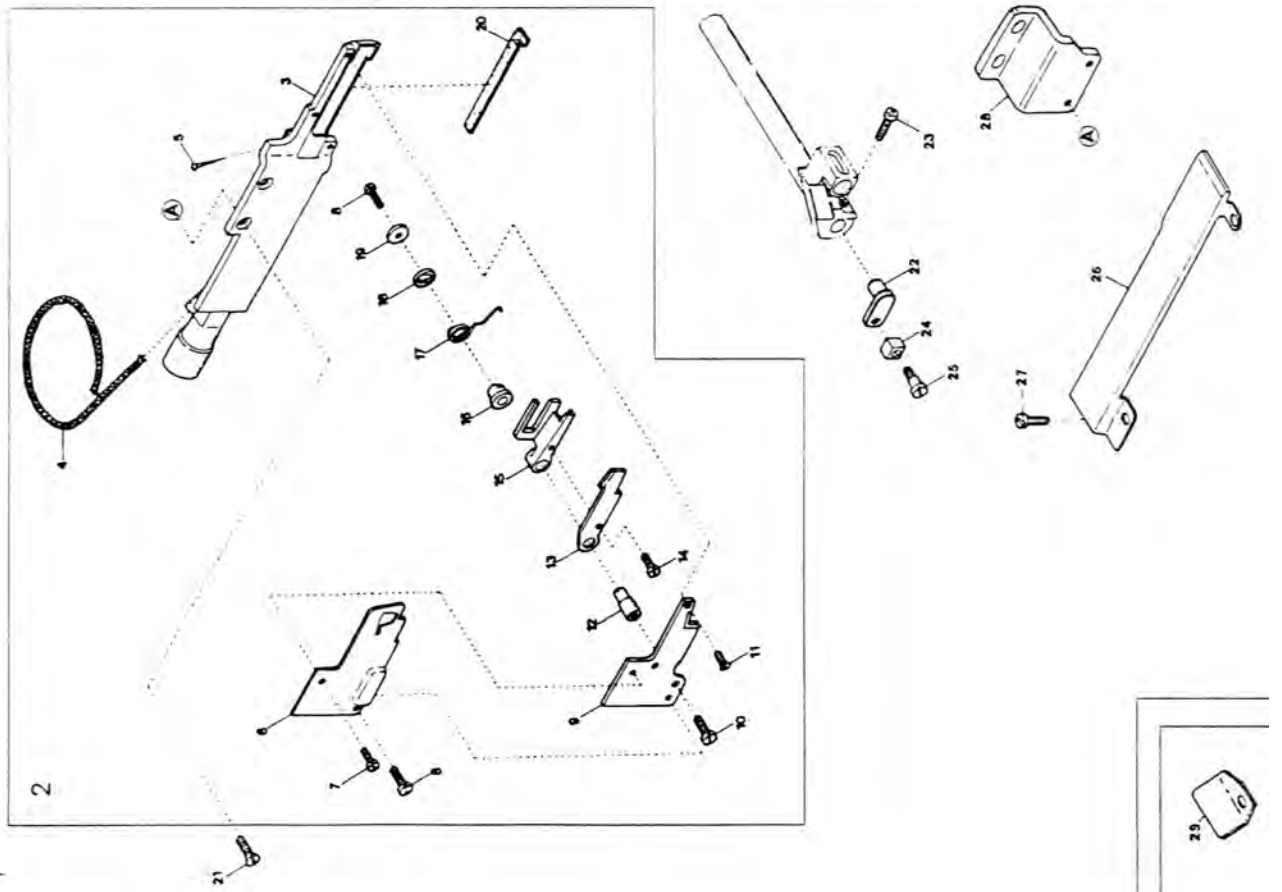

Ref. No.	Parts No.	Description	Am. Reg.
1	2109917	"K2" Device, Complete Set	1
2	2111050	Suction Pipe, Complete Set	1
3	2111051	Suction Pipe	1
4	310017	Oil Wick	1
5	000755	Oil Wick Pin	1
6	2111063	Suction Pipe Cover	1
7	004237	Screw (3/32-56X1.7)	1
8	004404	Screw (3/32-56X5.1)	2
9	2111055	Upper Trimming Knife	1
10	004131	Screw (1/8-44X6)	1
11	004139	Screw (3/32-56X3)	2
12	2111059	Lower Trimming Knife Holder Pin	1
13	2111056	Lower Trimming Knife	1
14	004236	Screw (3/32-56X4.2)	1
15	2111057	Lower Trimming Knife Driving Plate	1
16	2111062	Spring Sleeve	1
17	2111061	Lower Trimming Knife Pushing Spring	1
18	2111066	Spring Protect Washer	1
19	2111060	Washer	1
20	2111067	Air Shield Rubber	1
21	007623	Screw (9/64-40X5.3)	2
22	2111058	Lower Trimming Knife Guide Support	1
23	110068	Screw (M4-0.7x8)	1
24	2101011	Lower Trimming Knife Guide	1
25	270001	Screw (1/8-44X3)	1
26	2101059	Cloth Plate Spacer	1
27	110042	Screw (M3.5-0.6X4)	2
28	2101058	Suction Pipe Support	1
29	2107219	Presser Foot Chain Shield	1

RICAMBI YAMATO

"K1" DEVICE

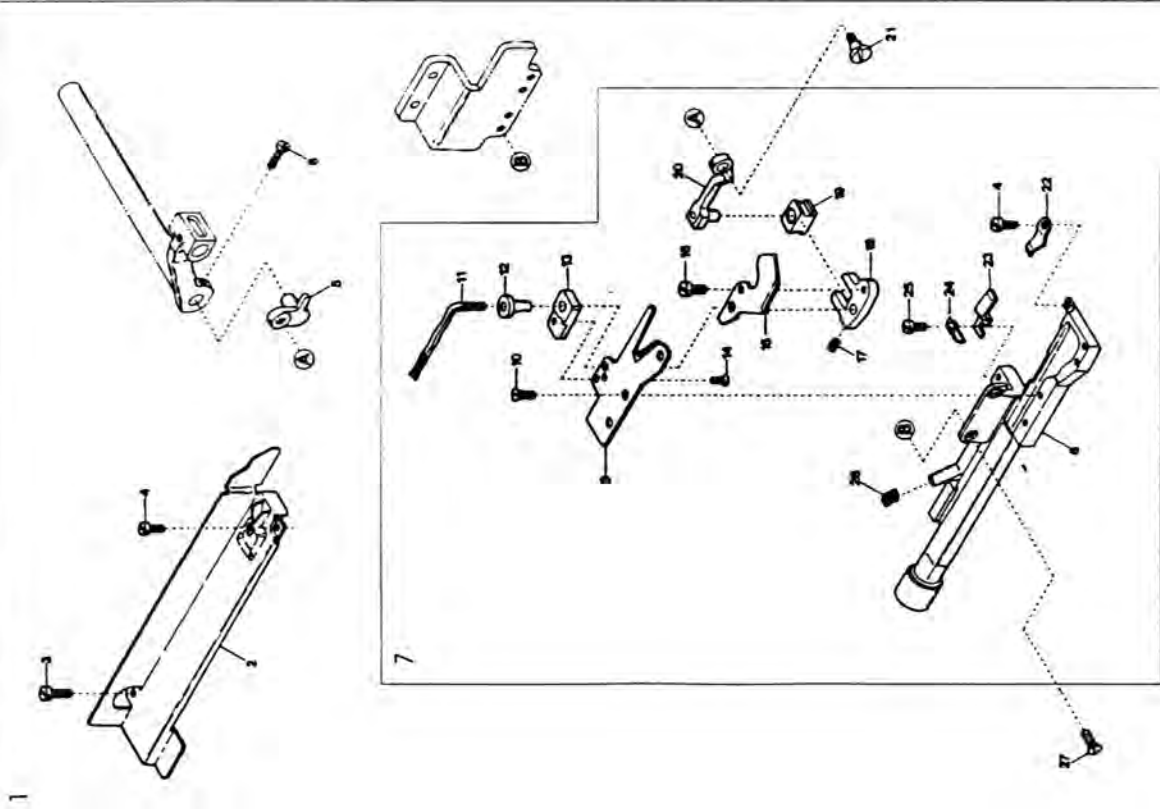

Ref. No.	Parts No.	Description	Am Reg
1	2109906	"K1" Device, Complete Set	1
2	2101167	Suction Pipe Cover	1
3	004314	Screw (1/8-44X5.6)	1
4	001230	Screw (3/32-56X3.8)	2
5	2101163	Lower Trimming Knife Driving Arm	1
6	110068	Screw (M4-0.7X8)	1
7	2101151	Suction Pipe, Complete Set	1
8	2101152	Suction Pipe	1
9	2101155	Upper Trimming Knife	1
10	005112	Screw (3/32-56X6)	2
11	000240	Oil Wick	1
12	2101160	Trimming Knife Holder Pin	1
13	2101161	Holder Pin Support	1
14	004139	Screw (3/32-56X3)	2
15	2101156	Lower Trimming Knife	1
16	110036	Screw (M3-0.5X6.5)	1
17	160001	Screw (M4-0.7X4)	1
18	2101157	Guide Block Holder	1
19	2101158	Lower Trimming Knife Guide Block	1
20	2101164	Lower Trimming Knife Driving Link	1
21	170010	Screw (M4-0.7X4)	1
22	2101159	Lower Trimming Knife Pushing Plate	1
23	2101166	Driving Link Presser	1
24	2101165	Oil Wick Clamp	1
25	001196	Screw (1/8-44X6)	1
26	310011	Felt	1
27	007623	Screw (9/64-40X5.3)	2

RICAMBI YAMATO

Parts for YAMATO VC2600/2700 series



0093170 (2ndl. 3.2mm)
0093171 (2ndl. 4.0mm)
0093172 (2ndl. 4.8mm)
Needle plate



0094801 (3ndl. 5.6mm)
0094802 (3ndl. 6.4mm)
Needle plate



3109000
3109002 (6.4mm)
Diff. feed dog



3109001
3109003 (6.4mm)
Main feed dog



0063318 (2ndl. 3.2mm)
0063319 (2ndl. 4.0mm)
0063320 (2ndl. 4.8mm)
Foot comp.



0064041 (3ndl. 5.6mm)
0064042 (3ndl. 6.4mm)
Foot comp.

VC2603/2703



0094210 (2ndl. 3.2mm)
0094211 (2ndl. 4.0mm)
0094212 (2ndl. 4.8mm)
Needle plate



0094901 (3ndl. 5.6mm)
0094902 (3ndl. 6.4mm)
Needle plate



3109018
3109021 (6.4mm)
Main feed dog



3109017
3109022 (6.4mm)
Diff. feed dog



0094215 (2ndl. 3.2mm)
0094216 (2ndl. 4.0mm)
0094217 (2ndl. 4.8mm)
Foot comp.



0094908 (3ndl. 5.6mm)
0094909 (3ndl. 6.4mm)
Foot comp.

VC2603-11/2703-11



0095234 (2ndl. 4.0mm)
Needle plate

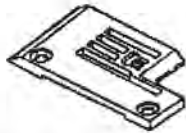

0095085 (3ndl. 5.6mm)
Needle plate



3109021
Main feeder



3109020
Diff. feeder



0095238 (2ndl. 4.0mm)
Foot comp.



0095089
(3ndl. 5.6mm)
Foot comp.

VC2742P



0067035 (3ndl. 5.6mm)
Needle plate



3109016
Main feeder



3109015
Diff. feeder



0067094
Foot comp.



0066567
Upper roller (rubber)

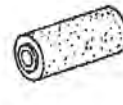

0067028
Lower roller (rubber)



0095061
Clutch



0065417
Clutch roller

Other parts



3109300
Looper



3109200
N. guard (Front)



3109201
N. guard (Rear)



3109310
Covering spreader

VC2713



3009021 (3ndl. 5.6mm)
Needle plate

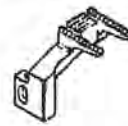

3109031
Main feeder



3109030
Diff. feeder



0094093
Foot comp. (3ndl. 5.6mm)

Parts for Yamato AZ8000 series

AZ8020, 8025, 8046



2109300
Lower looper
All classes



2109301
Upper looper
(needle #9 - 12)



2109303
Upper looper
(needle #13 - 16)



2109304
Upper looper
(needle #9 - 12)



2109305
Upper looper
(needle #13 - 16)

AZ8500



2109302
Chain looper

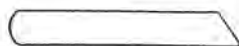

2100167
Lower knife



0020491
Upper knife















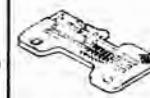



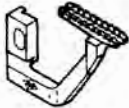

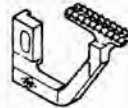
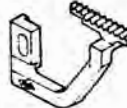









0020496
Upper knife













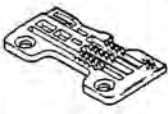
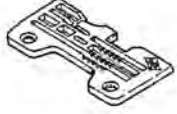



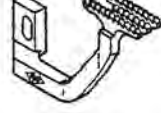
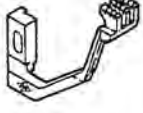
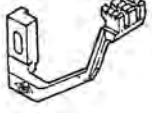

2109201
Needle guard

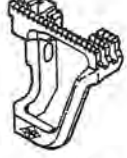
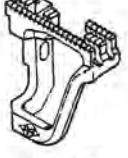





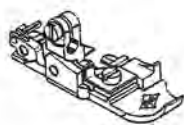
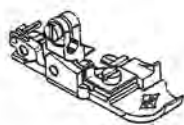
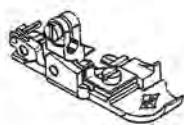
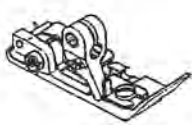
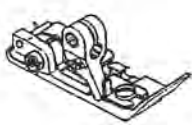
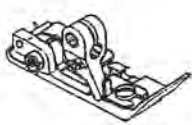
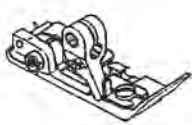











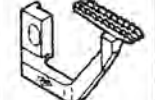

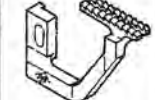
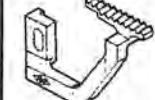











RICAMBI YAMATO

GAUGE SET	AZ6003H-		AZ6000H-	AZ6016H-	AZ6020H-		AZ6025H-	
	03 (0X3)	04 (0X4) 05 (0X5) 06 (0X6)	03 (0X3) 04 (0X4)	02	Y5 (2.4X5) Y6 (2.4X6)	X4 (2.0X4) X5 (2.0X5)	Y5 (2.4X5) Y6 (2.4X6)	X4 (2.0X4) X5 (2.0X5)
Throat Plate	 2108002	 2108003 2108007 2108012	 2108001 2108000	 2108016	 2108004 2108005	 2108006 2108014	 2108004 2108005	 2108006 2108014
Diff Feed Dog	 2109007	 2109005 2109005 2109009	 2109000	 2109017	 2109005 2109009			
Main Feed Dog	 2109006	 2109001	 2109018	 2109006				
Aux. Feed Dog	 2109052	 2109019	 2109052					
Needle Clamp asm.	 2109132			 2109130 2109131 2109130 2109131				
Presser foot asm.	 2107300	 2107301 2107302 2107303	 2107031 2107032	 2107084	 2107310 2107311	 2107312 2107313	 2107077 2107078	 2107079 2107081













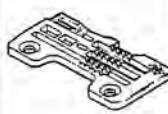
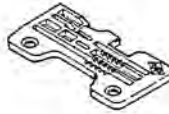

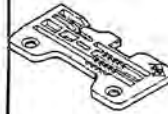

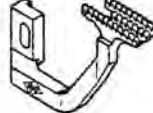
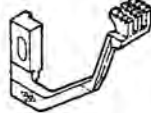
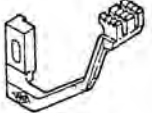
RICAMBI YAMATO

GAUGE SET	AZ6500H-					AZ6505H-	
	A4 (3.2X4)	A5 (3.2X5)	A6 (3.2X6)	C5 (5X5)	C6 (6X6)	A4 (3.2X4)	C5 (5X5)
Throat Plate	 2108050	 2108051	 2108056	 2108052	 2108053	 2108050	 2108052
Diff Feed Dog	 2109050	 2109057	 2109055	 2109060	 2109062		
Main Feed Dog	 2109051		 2109056	 2109061	 2109063		
Aux. Feed Dog			 2109052				
Needle Clamp asm.		 2109120		 2109122		 2109120	 2109122
Presser foot asm.	 2107100	 2107124	 2107125	 2107102	 2107126	 2107147	 2107149

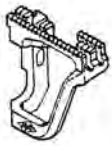





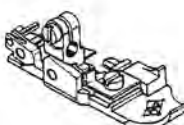
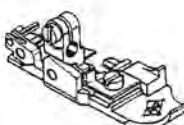
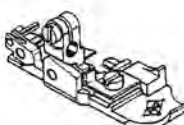
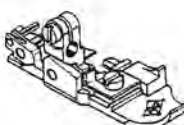
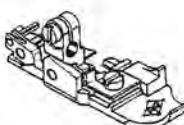
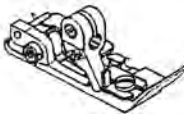
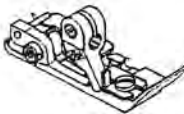





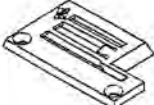





RICAMBI YAMATO

GAUGE SET	AZ8003H-		AZ8000H-	AZ8016H-	AZ8020H-		AZ8025H-		
	03 (0X3)	04 (0X4) 05 (0X5) 06 (0X6)	03 (0X3) 04 (0X4)	02 (0X2)	Y5 (2.4X5) Y6 (2.4X6)	X4 (2.0X4) X5 (2.0X5)	Y5 (2.4X5) Y6 (2.4X6)	X4 (2.0X4)	
Throat Plate	 2108002	 2108003 2108007 2108012	 2108001 2108000	 2108016	 2108004 2108005	 2108006 2108014	 2108004 2108005	 2108006	
Diff Feed Dog	 2109007	 2109005 2109005 2109009	 2109000	 2109017	 2109005 2109009				 2109005
Main Feed Dog	 2109006		 2109001	 2109018	 2109006				
Aux. Feed Dog	 2109067		 2109019		 2109067				
Needle Clamp asm.	 2109100			 2109101		 2109102	 2109101	 2109102	
Presser foot asm.	 2107300	 2107301 2107302 2107303	 2107031 2107032	 2107084	 2107310 2107311	 2107312 2107313	 2107308 2107309	 2107306	







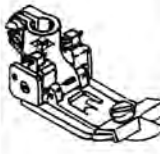
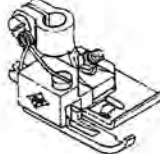

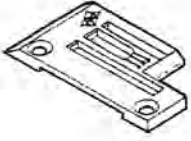
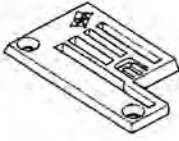
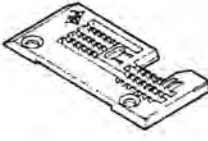
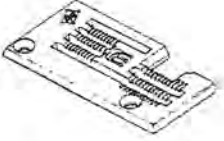

RICAMBI YAMATO

GAUGE SET	AZ8500H-					AZ8505H-	
	A4 (3.2X4)	A5 (3.2X5)	A6 (3.2X6)	C5 (5X5)	C6 (6X6)	A4 (3.2X4)	C5 (5X5)
Throat Plate	 2108050	 2108051	 2108056	 2108052	 2108053	 2108050	 2108052
Diff Feed Dog	 2109050	 2109057	 2109055	 2109060	 2109062		
Main Feed Dog	 2109051		 2109056	 2109061	 2109063		
Aux. Feed Dog			 2109052				
Needle Clamp asm.	 2109110		 2109112	 2109110	 2109112		
Presser foot asm.	 2107100	 2107124	 2107125	 2107102	 2107126	 2107147	 2107149



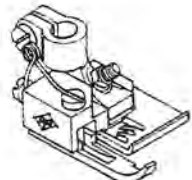
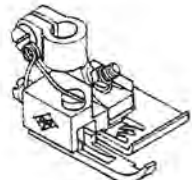
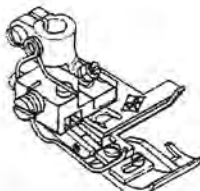
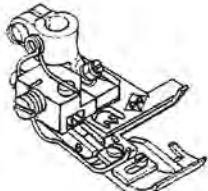

RICAMBI YAMATO

GAUGE SET	VF2400-		VF2500-		VF2403-		
	132M (232) 140M (240) 148M (248) 156M (256)	164M (264)	148M (348) 156M (356) 164M (364)	C (356)	132M (232) 140M (240) 148M (248) 156M (256)	164M (264)	140M-11 (240)
Throat Plate	 0093170 0093171 0093172 0093173	0093174	 0094800 0094801 0094802	 94801B	 0094281 0094282 0094283 0094284	0094285	 0095234
Diff Feed Dog	 3209001	3209003	 3209001 3209001 3209003	 3209001C	 3209005	3209007	 3209009
Main Feed Dog	 3209000	3209002	 3209000 3209000 3209002	 3209000	 3209004	3209006	 3209008
Needle Clamp asm.	 3209100 3209101 3209102 3209103	3209104	 3209106 3209107 3209108	3209107	 3209100 3209101 3209102 3209103	3209104	3209101
Presser foot asm.	 0095580 0095581 0095582	0095584	 0095586 0095587 0095588	 64041-N	 0094215 0094216 0094217	0094219	0095238

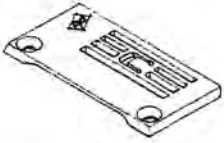
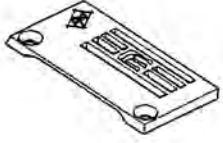
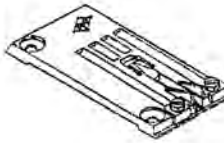
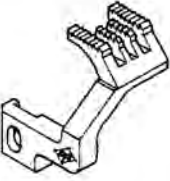
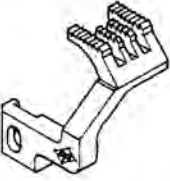
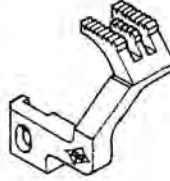
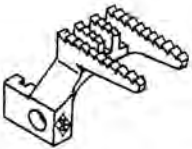
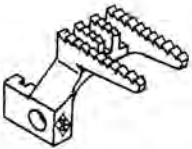

RICAMBI YAMATO

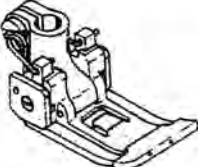
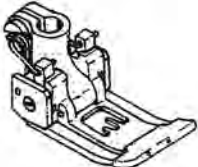
GAUGE SET	VF2503-		VF2409-	VF2509-
	156M (356) 164M (364)	156M-11 (356)	140M (240) 148M (248)	156M (356) 164M (364)
Throat Plate	 0094921 0094922	 0095085	 0095261 0095262	 0095278 0095279
Diff Feed Dog	 3209005 3209007	 3209009	 3209013	
Main Feed Dog	 3209004 3209006	 3209008	 3209012	
Needle Clamp asm.	 3209107 3209108	 3209107	 3209101 3209102	 3209107 3209108
Presser foot asm.	 0094908 0094909	 0095089	 0095314 0095315	 0095316 0095317

RICAMBI YAMATO

GAUGE SET	VC2600-		VC2700-		
	132M (232) 140M (240) 148M (248) 156M (256)	164M (264)	148M (348) 156M (356)	164M (364)	C (356)
Throat Plate	 0093170 0093171 0093172 0093173	0093174	 0094800 0094801	0094802	 94801B
Diff Feed Dog	 3109000	3109002	 3109000	3109002	 3109030
Main Feed Dog	 3109001	3109003	 3109001	3109003	3109001
Needle Clamp asm.	 0093351 0093352 0093353 0093354	0093355	 0093356 0093357	0093358	0093357
Presser foot asm.	 0063318 0063319 0063320 0063321	0063322	 3107050 0064041	0064042	 64041-N

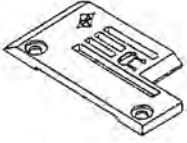
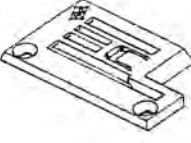
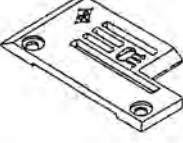
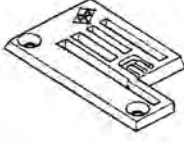
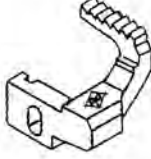
RICAMBI YAMATO

GAUGE SET	VC2603-			VC2703-	
	132M (232) 140M (240) 148M (248) 156M (256)	164M (264)	140M-11 (240)	156M (356) 164M (364)	156M-11 (356)
Throat Plate	 0094210 0094211 0094212 0094213	0094214	 0095234	 0094901 0094902	 0095085
Diff Feed Dog	3109017	3109022	 3109020	3109017 3109022	3109020
Main Feed Dog	3109018	3109021	 3109021	3109018 3109021	3109021
Needle Clamp asm.	0093351 0093352 0093353 0093354	0093355	0093352	0093357 0093358	0093357
Presser foot asm.	0094215 0094216 0094217 0094218	0094219	0095238	0094908 0094909	0095089