

RICAMBI SINGER

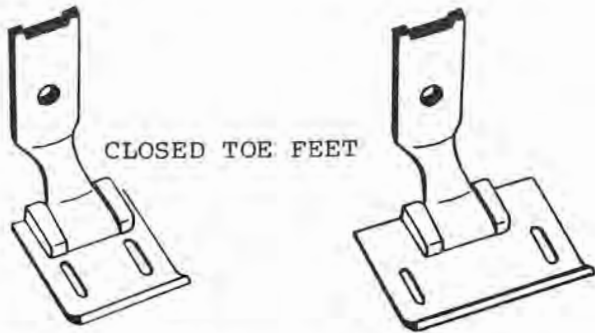

CLOSED TOE FEET

CLOSED TOE FEET		
224127 - 1/32"	223759 - 3/8"	223759 - 13/16"
224127 - 1/16"	223759 - 13/32"	223759 - 7/8"
224158 - 3/32"	223759 - 7/16"	223759 - 15/16"
224158 - 1/8"	223759 - 15/32"	223759 - 1"
224158 - 5/32"	223759 - 1/2"	223759 - 1-1/8"
224158 - 3/16"	223759 - 17/32"	223759 - 1-1/4"
223759 - 7/32"	223759 - 9/16"	223759 - 1-3/8"
223759 - 1/4"	223759 - 19/32"	223759 - 1-1/2"
223759 - 9/32"	223759 - 5/8"	223759 - 1-5/8"
223759 - 5/16"	223759 - 11/16"	223759 - 1-3/4"
223759 - 11/32"	223759 - 3/4"	223759 - 2"

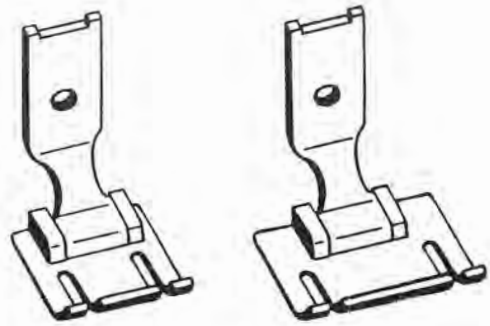

OPEN TOE FEET	
223799 - 1/8"	224082 - 1/2"
223799 - 5/32"	224082 - 9/16"
223799 - 3/16"	224084 - 5/8"
224062 - 7/32"	223771 - 3/4"
224062 - 1/4"	224133 - 7/8"
224062 - 9/32"	224068 - 1"
224062 - 5/16"	224086 - 1-1/8"
224080 - 11/32"	224088 - 1-1/4"
224080 - 3/8"	224088 - 1-3/8"
224080 - 7/16"	224078 - 1-1/2"

FEED DOGS

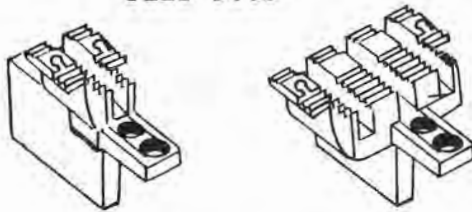

FEED DOGS		
223637 - 1/32"	223628 - 3/8"	223632 - 13/16"
223637 - 1/16"	223628 - 13/32"	224013 - 7/8"
223637 - 3/32"	223632 - 7/16"	224013 - 15/16"
223637 - 1/8"	223632 - 15/32"	224013 - 1"
223637 - 5/32"	223632 - 1/2"	224013 - 1-1/8"
223639 - 3/16"	223632 - 17/32"	224013 - 1-1/4"
223639 - 7/32"	223632 - 9/16"	224013 - 1-3/8"
223628 - 1/4"	223632 - 19/32"	224013 - 1-1/2"
223628 - 9/32"	223632 - 5/8"	224013 - 1-5/8"
3628 - 5/16"	223632 - 11/16"	224013 - 1-3/4"
3628 - 11/32"	223632 - 3/4"	224013 - 2"

THROAT PLATES

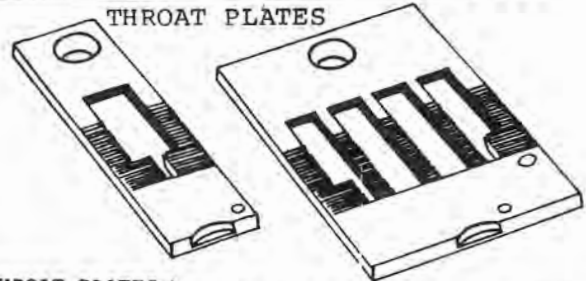

THROAT PLATES		
224030 - 1/32"	223884 - 3/8"	224033 - 13/16"
224030 - 1/16"	223884 - 13/32"	224029 - 7/8"
224030 - 3/32"	224033 - 7/16"	224029 - 15/16"
224030 - 1/8"	224033 - 15/32"	224029 - 1"
224030 - 5/32"	224033 - 1/2"	224029 - 1-1/8"
224031 - 3/16"	224033 - 17/32"	224029 - 1-1/4"
224031 - 7/32"	224033 - 9/16"	224029 - 1-3/8"
223884 - 1/4"	224033 - 19/32"	224029 - 1-1/2"
223884 - 9/32"	224033 - 5/8"	224029 - 1-5/8"
223884 - 5/16"	224033 - 11/16"	224029 - 1-3/4"
223884 - 11/32"	224033 - 3/4"	224029 - 2"

212W NEEDLE CLAMPS



267269 - 1/32"	267269 - 3/8"	267270 - 13/16"
267269 - 1/16"	267269 - 13/32"	267271 - 7/8"
267269 - 3/32"	267269 - 3/16"	267271 - 15/16"
267269 - 1/8"	267269 - 15/32"	267271 - 1"
267269 - 5/32"	267270 - 1/2"	267271 - 1-1/8"
267269 - 3/16"	267270 - 17/32"	267271 - 1-1/4"
267269 - 7/32"	267270 - 9/16"	267271 - 1-3/8"
267269 - 1/4"	267270 - 19/32"	267271 - 1-1/2"
267269 - 9/32"	267270 - 5/8"	267271 - 1-5/8"
267269 - 5/16"	267270 - 11/16"	267271 - 1-3/4"
267269 - 11/32"	267270 - 3/4"	267271 - 2"

112W NEEDLE CLAMPS

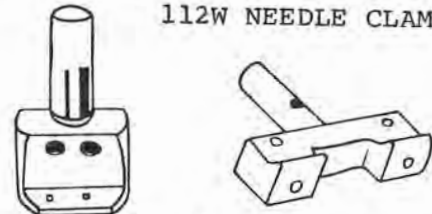

236650 - 1/16"	223863 - 1/2"
223878 - 3/32"	223863 - 9/16"
223878 - 1/8"	223863 - 5/8"
223878 - 5/32"	223863 - 3/4"
223878 - 3/16"	223864 - 7/8"
223878 - 7/32"	223864 - 1"
223878 - 1/4"	223864 - 1-1/8"
223878 - 9/32"	223864 - 1-1/4"
223878 - 5/16"	223864 - 1-3/8"
223878 - 11/32"	223864 - 1-1/2"
223878 - 3/8"	223864 - 1-5/8"
223878 - 7/16"	223864 - 1-3/4"



237181 1/8" 5/32" 3/16" 1/4" 5/16" 3/8" 7/16" 1/2"
 9/16" 5/8" 11/16"
 237182 3/4" 7/8" 1" 1-1/8" 1-1/4" 1-3/8" 1-1/2"
 1-5/8" 1-3/4"
 Needle Bar & Holder Assembly

RICAMBI SINGER



S570 (P112B) 1/8" 3/16" 1/4" 5/16"
3/8" 7/16" 1/2" 9/16"
Brassiers Foot With
Compensating Guide



S570L 1/8" 3/16" 1/4" 5/16"
3/8" 7/16" 1/2" 9/16"
Brassiers Foot With
Compensating Guide

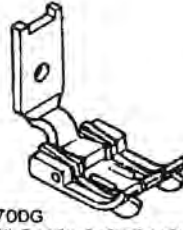

S570DG
1/4" 5/16" 3/8" 7/16"
1/2" 9/16" 5/8" 3/4"
7/8" 1" 1-1/8" 1-1/4"
1-3/8" 1-1/2"
Brassiers Foot With
Compensating Guide

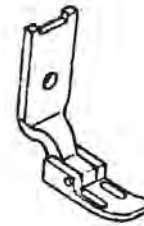

259635 1/8" 3/16" 1/4"
Closed Toe Aipper Foot

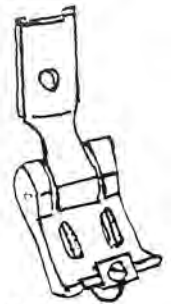

S570REG 2 aghi
prua regolabile 3/16-1/4

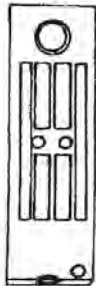

236405 1/8"
236409 3/16"
236413 1/4"
236421 5/16"
236425 3/8"
Box Type
236427 1/16" 1/2"
236430 9/16" 5/8"
236436 9/4" 7/8"
236444 1" 1-1/8"
236450 1-1/4"
236454 1-3/8" 1-1/2"
1-5/8" 1-3/4"
Standard Type

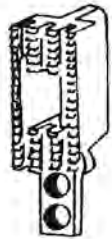

236403 1/8"
236411 3/16" 1/4"
236419 5/16"
236423 3/8"
Box Type
211669 7/16" 1/2"
211674 9/16" 5/8"
211685 3/4" 7/8"
211693 1" 1-1/8"
211698 1-1/4"
236452 1-3/8" 1-1/2"
1-5/8" 1-3/4"
Standard Type

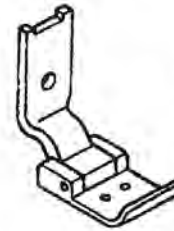

229094 1/8" 3/16"
229096 1/4" 5/16"
229098 3/8" 7/16"
229139 1/2"
229141 9/16" 5/8"
3/4"
229145 7/8"
229147 1"
229149 1-1/8"
229153 1-1/4" 1-3/8"
1-1/2" 1-5/8"
1-3/4"
Presser Foot

Parts for Singer 107W, 457G, 457U etc.



HT107
Teflon foot

Teflon bottom only HT107B

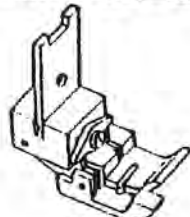

S107CL
Compensating foot
with left edge guide

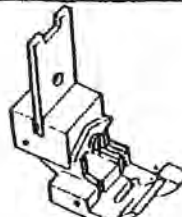

S107CR
Compensating Foot
with right edge guide



HT112
Teflon foot

All sizes available
Replaceable teflon bottom HT112B

FOR107G,457G

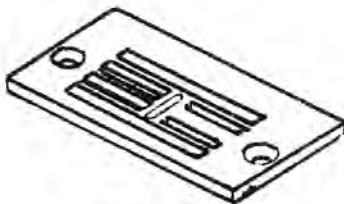

S03605
Throat Plate

GAUGE SET FOR "SINGER" MACHINES

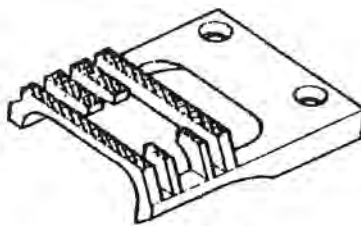

266008
Feed Dog



S03595
Presser Foot (457G140)

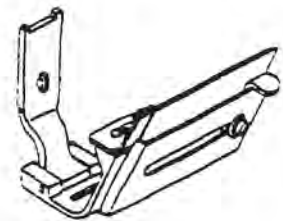

S571G
guida nastro zig zag

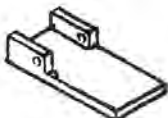

S548 9/16" 5/8" 3/4"
1" 1-1/4" 1-1/2" 2"
Bottom



S21020
Shank



S107B
Hinged Blank Foot

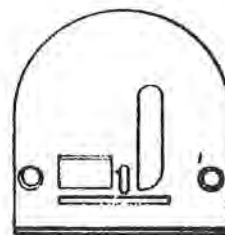

S21028P
Throat Plate



S21028F
Feed Dog

RICAMBI SINGER

FOR 107G, 475G

GAUGE SET FOR "SINGER" MACHINES

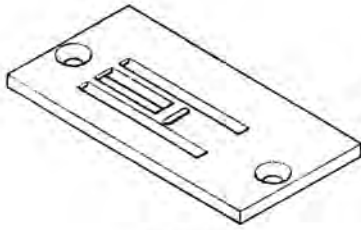

210600
Throat Plate

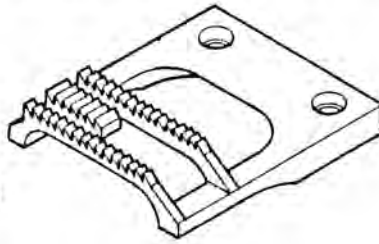

210518 (14 Teeth)
502547 001 (15 Teeth)
Feed Dog

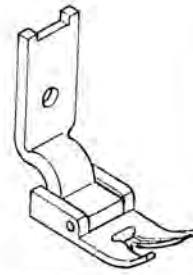

210568
Presser Foot

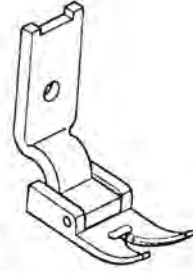

210569 (P107)
Presser Foot

FOR 107G, 475G

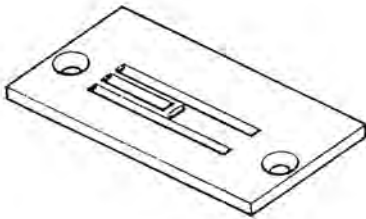

241372
Throat Plate

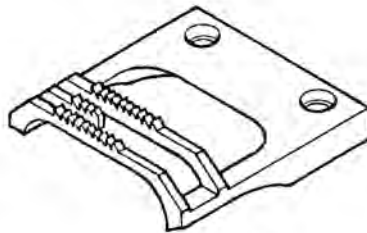

241373
Feed Dog

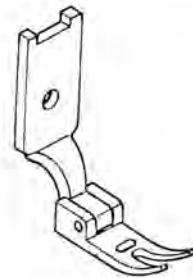

241375 (P375)
Presser Foot

FOR 107G, 475G

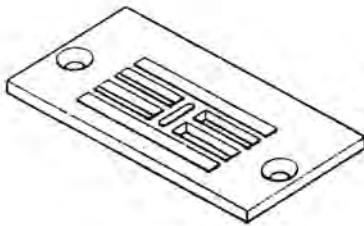

503733
Throat Plate

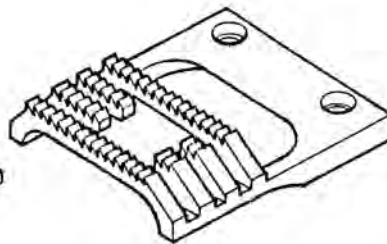

503734
Feed Dog

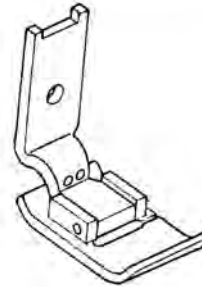

503595
Presser Foot

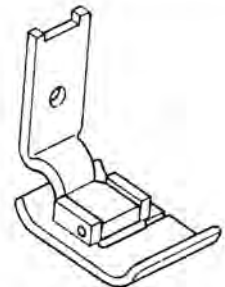

503736
Presser Foot

FOR 107G, 475G



503682
Throat Plate

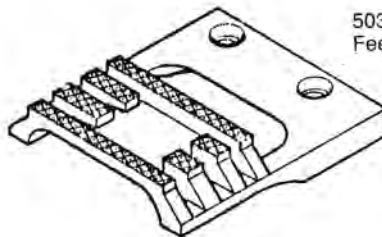

503683
Feed Dog

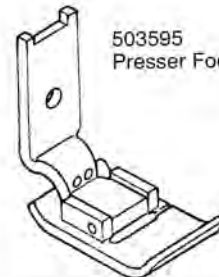

503595
Presser Foot

FOR 107G, 475G

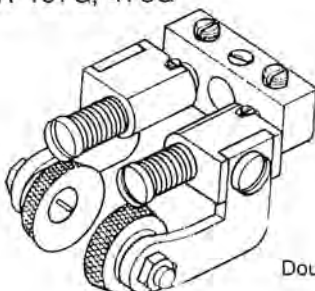

S520
Double Roller Presser Foot

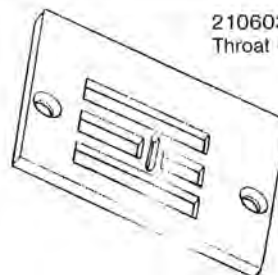

210603
Throat Plate

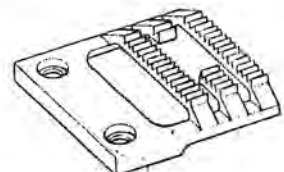

210523
Feed Dog

RICAMBI SINGER

TRASFORMAZIONE PER MACCHINA A BRACCIO ROVESCiato

per Singer - Necchi - Brother

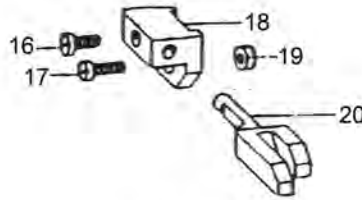
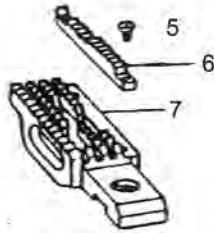

148867 griffa completa
 5 - 147880 vite
 6 - 147307 griffina supplementare
 7 - 148971 griffa principale
 150672CPL piedino 3 aghi per puller completo di forcina
 150672 solo ciabatta



16 - 111443 vite
 17 - 009671-0-14 vite
 18 - 148876 supporto salva ago
 19 - 021670-1-02 dado
 20 - 148875 salva ago

3 - 148869
 4 - 148870
 5 - 148871
 6 - 148872
 7 - 148873
 8 - 148874

classe 231;253;261;262



139138 3/16"
 139138 1/4"

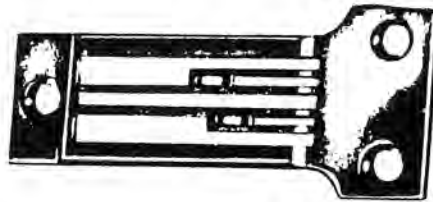

139186 3/16"
 139186 1/4"



139049 3/16"
 139049 1/4"



139541 3/16"
 139541 1/4"



139540 3/16"
 139540 1/4"

Parts for Singer 20U



541674
 Hook complete

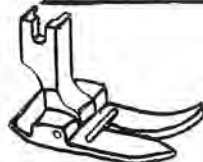

541566
 Presser Foot

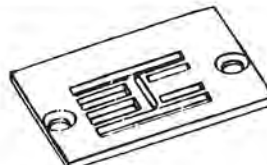

541936
 Needle Plate



541647
 Feed Dog



541678
 Bobbin Case



543939
 Presser Foot

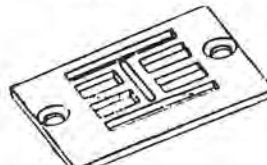

543977
 Needle Plate



543978
 Feed Dog

RICAMBI SINGER

FOR 231, 261

GAUGE SET FOR "SINGER" MACHINES

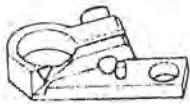

143481
Looper Holder (Back)

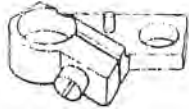

143482
Looper Holder (Front)

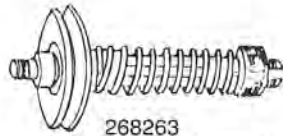

268263
Tension Complete



131696
Tension (Needle Thread)
Thread Guide

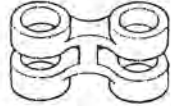

139064
Looper Driving Arm
Connecting Link



139289
Looper Holder



139093 3/16" 1/4"
Looper Holder

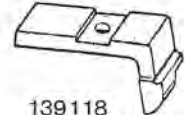

139118
Needle Guard, 1/4"

FOR 231, 261

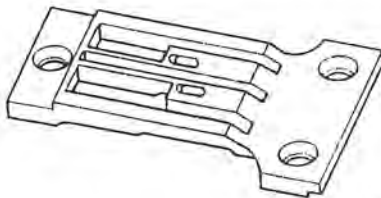

139385 1/4"
Throat Plate

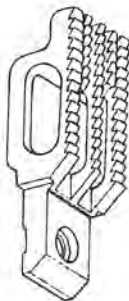

139382 1/4"
Feed Dog
14 teeth
10 teeth to 1"

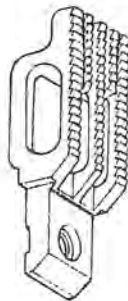

139414 1/4"
Feed Dog
11 teeth
8 teeth 1"

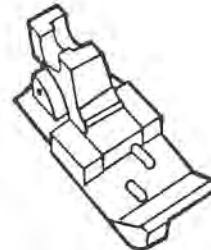

139223
Triple Hinged
Presser Foot



139116 3/16" 1/4"
Needle Clamp

FOR 231

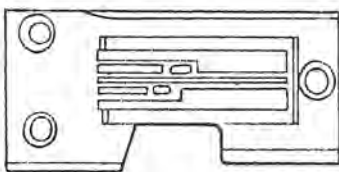

139460 3/16" 1/4"
(139549 3/16" 1/4")
Throat Plate

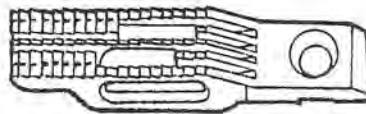

139364 3/16" 1/4"
(139548 3/16" 1/4")
Feed Dog



139245 3/16" 1/4"
Hinged Presser Foot, Complete



139116 3/16" 1/4"
Needle Clamp

FOR 231, 261

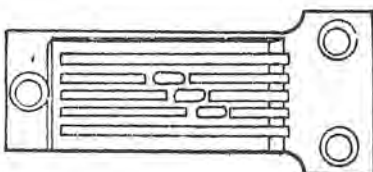

139500-501 Throat Plate

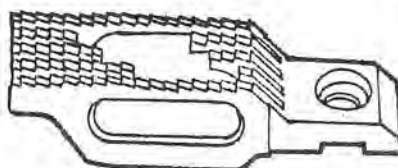

139499-501
Feed Dog Teeth, B Teeth to 1"

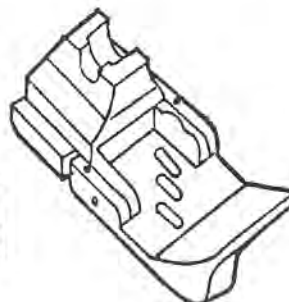

139405-501
Triple Hinged Presser Foot

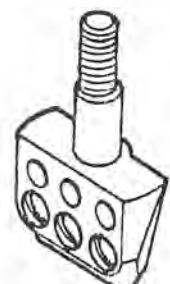

128215-501
Needle Clamp

RICAMBI SINGER

classe 175

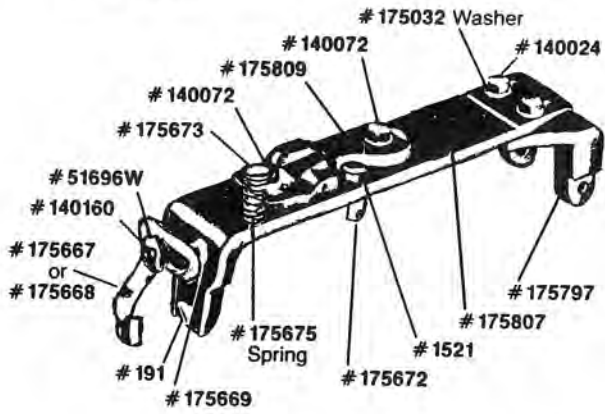

ADJUSTABLE
SHANK FOOT
LW 501



ADJUSTABLE
SHANK FOOT
LW 502



ADJUSTABLE
SHANK FOOT
LW 503



175392



175393



175398



175399



175676



- supporto grezzo -
175 SB



175890



175889



430-75
Vite # 18-318
Scartafilo # 122-45



T 175

classe 269W



17855



- # 214053 molla



131022
anello di
gomma



17859



17864



1204 vite



68739



1318 vite



223711



39222



63976



51948



- # 167087 (# 239272) barra ago
- # 239376 guidafilo # 200125 vite per ma ago
- # 201143 vite per guidafilo



- # 1819
per # 3072



per # 18393 # 1822

RICAMBI SINGER

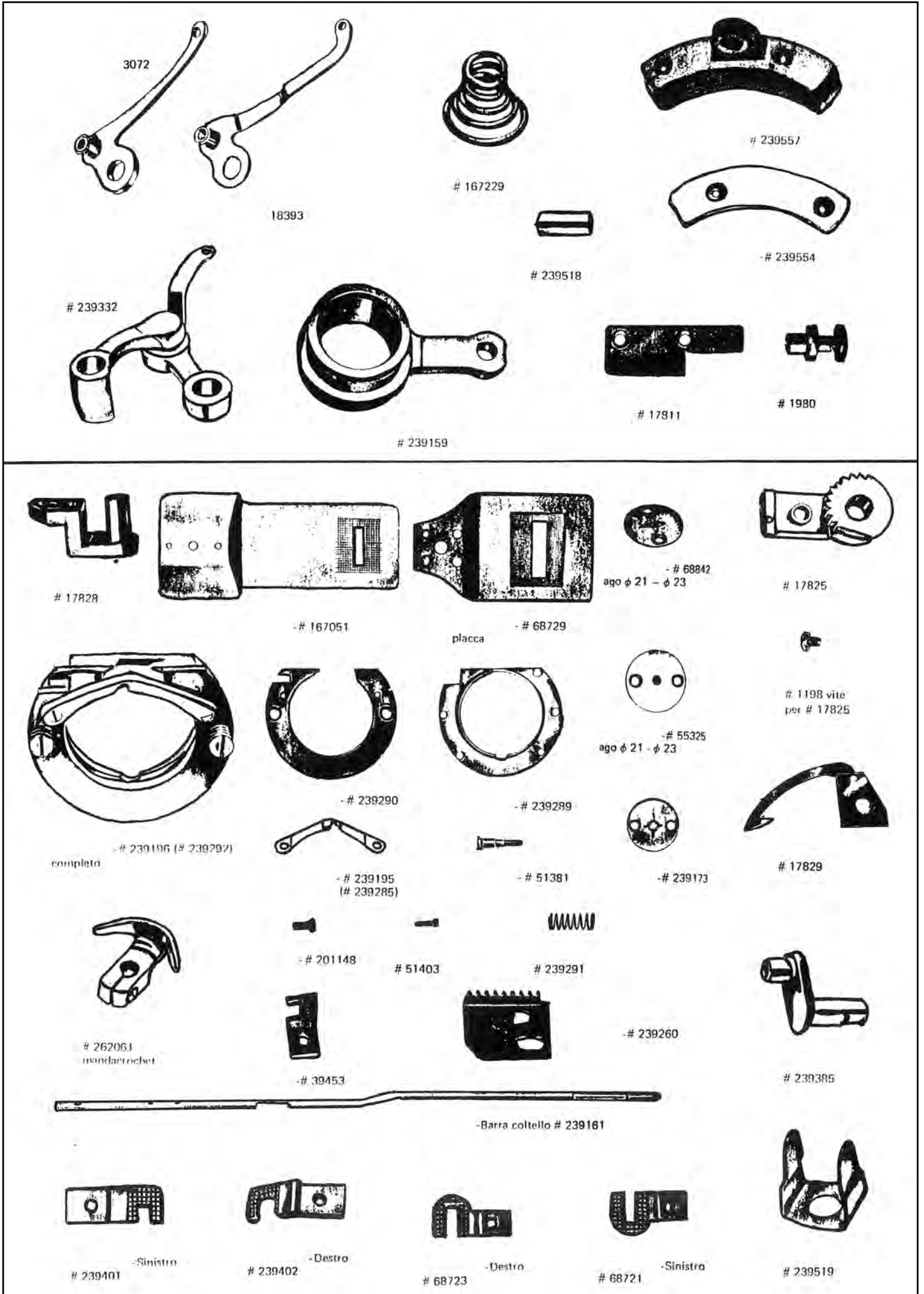

RICAMBI SINGER



239158
filarello completo



228795



239157 supporto



228794
asse filarello



60770
supporto completo
della tensione



17797
Ingranaggio (42 punti)



18415
(42 punti)



17854
1206
vite per # 17854

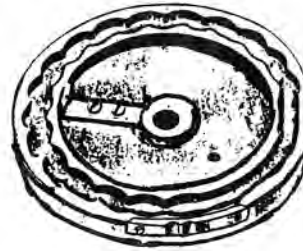

18407
Cam (48 punti)
55454
Cam (28 punti)



239366
(# 167163) tensione

68, 69, 269 W, 270



55459



55458



239372



239367

281



785780-001

369



499919



499920



239715

300 W

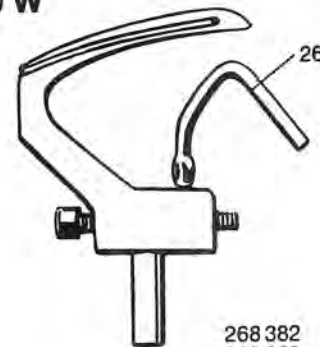

268310

268382
268380
268369

**coltelli e crochet per tagliacuci:
vedi "crochet Singer" "coltelli Singer"**

RICAMBI SINGER

KL 231-261



32820



32821



32823



32824



269342-502 deragliatore



40986B rullo puller bianco
40986N rullo puller nero

CL. 491D; 591C; 591D; 601D



A6090 (544784)



A7002 (52237MF)



544875



544782

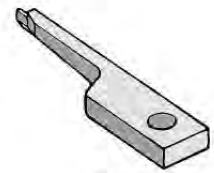

545881

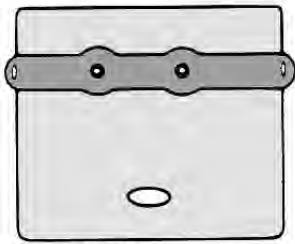

505317



540702



505575



540663



540671

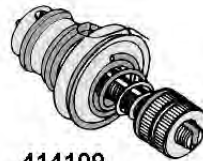

414109



541182



32758



545892

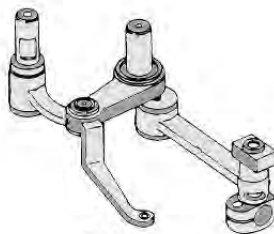

543416



540676



544821



410705



544857

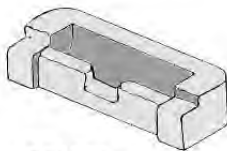

540523



540500



546925

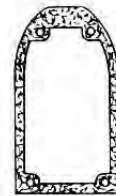

545773



540762



540549

KL 591D - 591E



414030



414029



540741



540760



411146 Camme Singer



414409 tirante Singer 591

RICAMBI SINGER



502508 kl 457
 522008 kl 121C-141C centurion
 268270 kl 300W-320W-302U

224303 kl 107W100
 224513 kl 108W20 new style
 235502 kl 118W

400 W 11



270616
vidia



270619
vidia



270616



270619



175085



175547

175

KL 96K - 451K11



147211 (276489)
vidia



5730-142032-52131
3/32-1/8-3/16

KL 71K - 271K

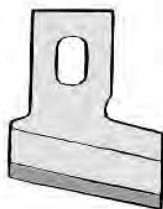
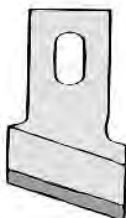

mm 3,2 (1/8")	mm 20 (13/16")
mm 6,5 (1/4")	mm 22,2 (7/8")
mm 8 (5/16")	mm 24 (15/16")
mm 9,5 (3/8")	mm 25,4 (1")
mm 11 (7/16")	mm 27 (1.1/16")
mm 12,7 (1/2")	mm 28,6 (1.1/8")
mm 14,7 (9/16")	mm 30 (1.3/16")
mm 16 (5/8")	mm 31,7 (1.1/4")
mm 17,5 (1.1/16")	mm 38 (1.1/2")
mm 19 (3/4")	



190 vite piedino



208 vite griffa



284 vite guide lunga



286 vite guide corta



691 vite placca



857 vite ago



1198 vite coltello



1318 vite camme



1498 grano ago



51381 vite slitta



51403 vite slitta



140239 vite ago



201148



500256 vite piedino



Morsetto 2 aghi
 sganciabili
 FL700 3/16
 FL701 1/4
 FL702 5/16
 FL703 3/8
 FL704 1/2

7014 vite

7013 molla

7012 dado zigrinato

7011 perno porta ago
 (precisare sempre la
 distanza aghi per lo
 spessore dei perni)