

# RICAMBI YAMATO

FOR DCZ-200-D2

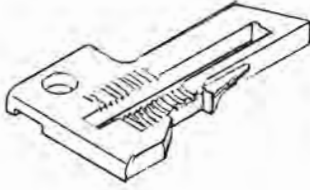

32667  
Stitch Plate

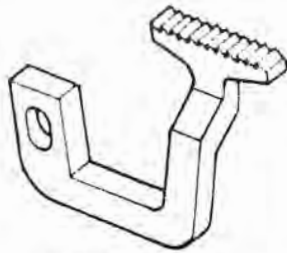

33810  
Differential Feed Dog

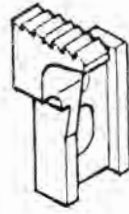

33811  
Main Feed Dog



32883  
Auxiliary Feed Dog

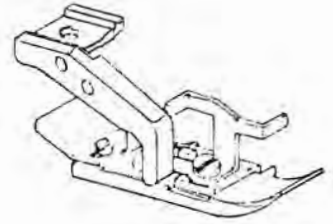

32734  
Presser Foot

FOR DCZ-200-D1

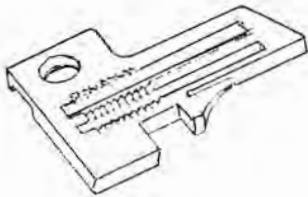

34893  
Stitch Plate

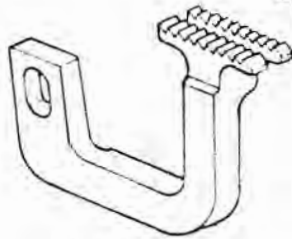

34852  
Differential Feed Dog

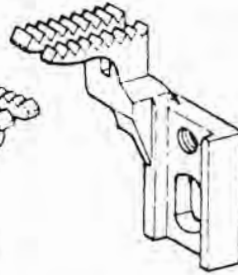

34851  
Main Feed Dog



32883  
Auxiliary Feed Dog

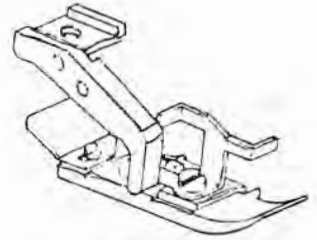

32345  
Presser Foot

FOR DCZ-216

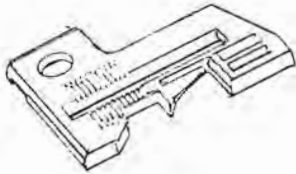

34420  
Stitch Plate

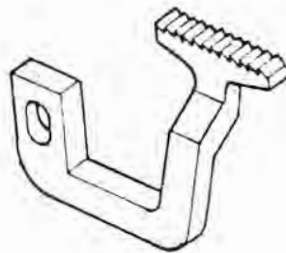

33812  
Differential Feed Dog



33811  
Main Feed Dog



33328  
Auxiliary Feed Dog

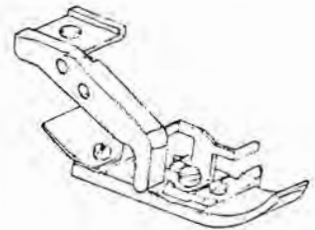

34922  
Presser Foot

FOR DCZ-203

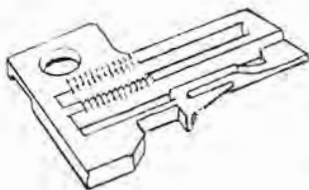

32671  
32672  
32673  
Stitch Plate

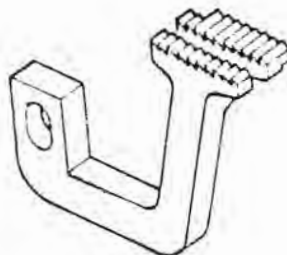

33813  
Differential Feed Dog

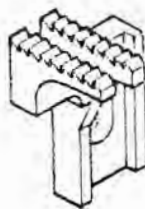

33814  
33818  
Main Feed Dog

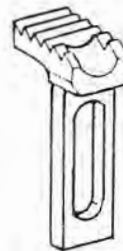

32883  
Auxiliary Feed Dog

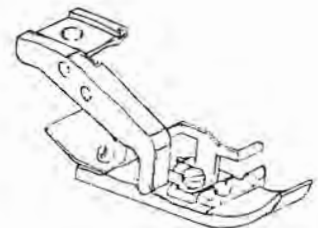

32747  
32748  
Presser Foot

FOR DCZ-200W-D1

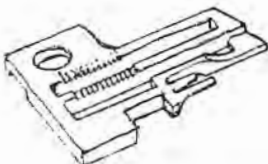

32678  
Stitch Plate

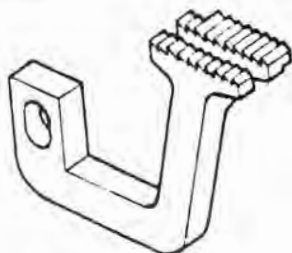

33813  
Differential Feed Dog

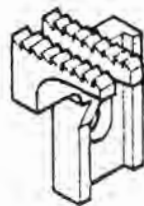

33814  
Main Feed Dog



32883  
Auxiliary Feed Dog

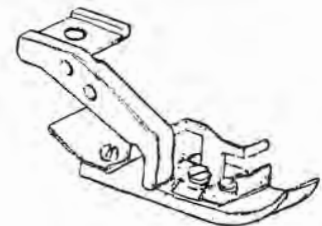

32750  
Presser Foot

# RICAMBI YAMATO

FOR DCZ-222/223

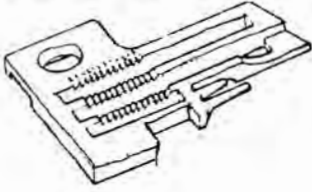

32571  
Stitch Plate

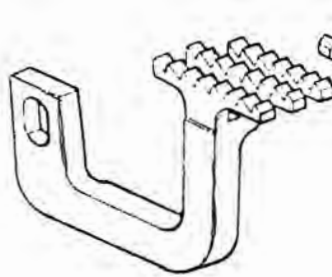

33819  
Differential Feed Dog

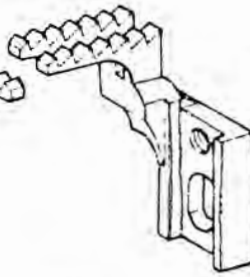

33818  
Main Feed Dog



32557  
Auxiliary Feed Dog

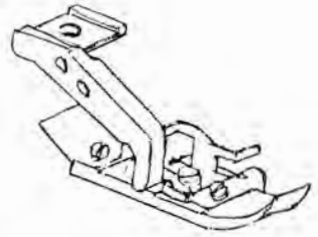

32579  
Presser Foot

FOR DCZ-503-D1  
-D2

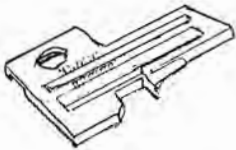

34564  
34565  
34566  
Stitch Plate

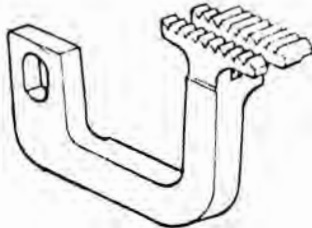

33840  
Differential Feed Dog



33814  
Main Feed Dog



32883  
Auxiliary Feed Dog

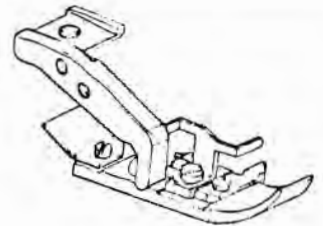

32747  
327748  
Presser Foot

DCZ-520-D1/520W-D1

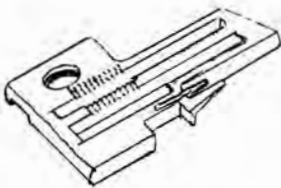

34598 (34585)  
34593  
Stitch Plate

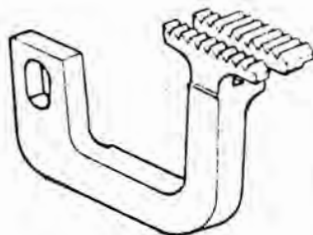

33840  
Differential Feed Dog



33814  
Main Feed Dog



32883  
Auxiliary Feed Dog

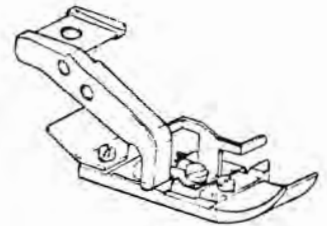

32750  
32760  
Presser Foot

DCZ-521-D1

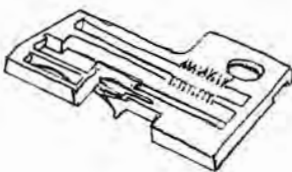

34600  
Stitch Plate

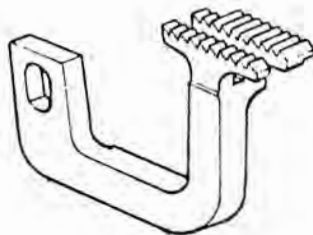

33840  
Differential Feed Dog



33814  
Main Feed Dog



32341  
Auxiliary Feed Dog

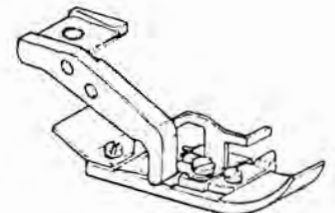

32343  
Presser Foot

DCZ-361A/362A

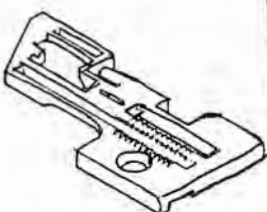

33541  
Stitch Plate

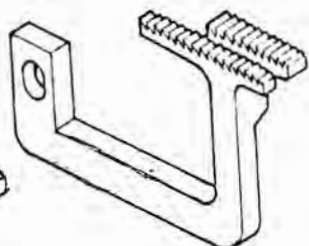

33824  
Differential Feed Dog

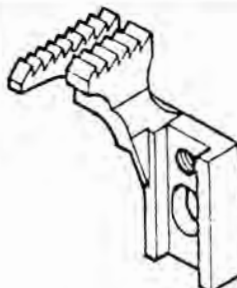

33825  
Main Feed Dog



33544  
Auxiliary Feed Dog

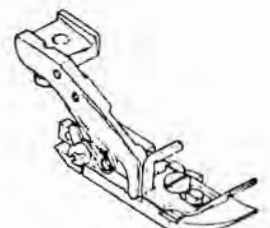

33537  
Presser Foot

# RICAMBI YAMATO

## FOR DCZ-361C/362C

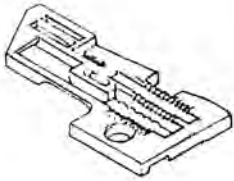

33545  
Stitch Plate

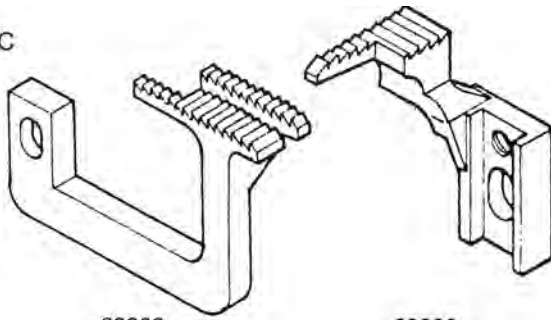

33828  
Differential Feed Dog

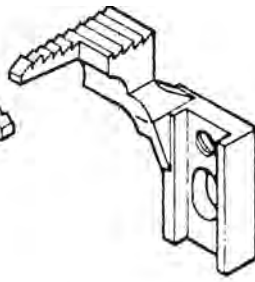

33829  
Main Feed Dog



33328  
Feed Dog

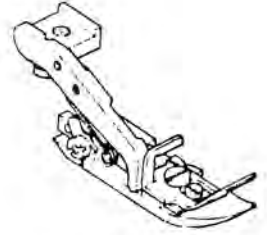

33539  
Presser Foot

## FOR DCZ-341C-D4

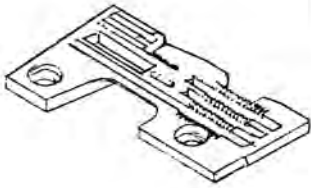

35334  
Stitch Plate

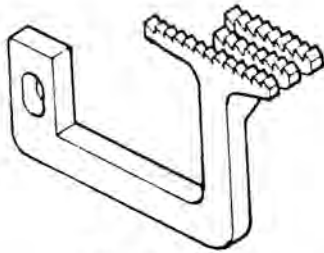

35335  
Differential Feed Dog

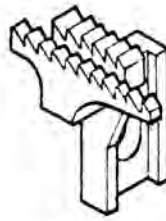

35331  
Main Feed Dog



35264  
Auxiliary Feed Dog

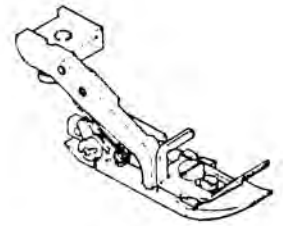

35263  
Presser Foot

## FOR DCZ-341C-D4-1

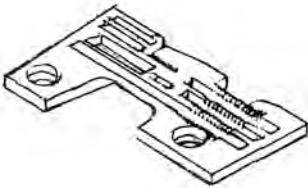

35334  
Stitch Plate

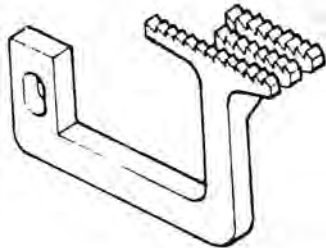

35335  
Differential Feed Dog

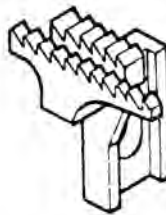

35331  
Main Feed Dog



35264  
Auxiliary Feed Dog

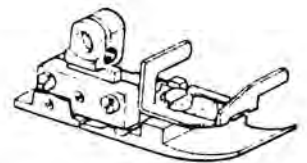

35325  
Presser Foot

## FOR DCZ-361



33515  
Foot Chip Guard



33304  
Foot Hinge Spring

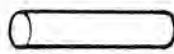

731  
Foot Pin



33525  
Foot Spring (Large)



33526  
Foot Spring (Small)

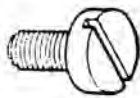

5036  
Screw

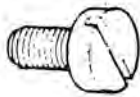

1226  
Screw



1228  
Screw



216  
Nut

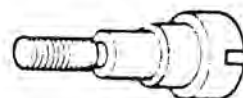

6093  
Screw



33529  
Presser Foot  
Adjusting Plate



4404  
Screw



5401  
Screw



3637  
Screw



3638  
Screw



37919  
Hexagon Screw Driver



1092  
Screw



32706  
Chain Cutter



32425  
Needle Bar Thread  
Retainer Plate

# RICAMBI YAMATO



38101  
Needle Clamp



33247  
Needle Clamp

FOR DCZ-361

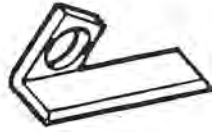

33087  
Needle Guard (Front)

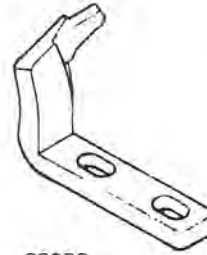

33088  
Needle Guard (Rear)

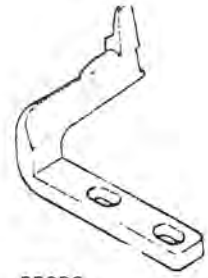

33086  
Needle Guard (Rear)

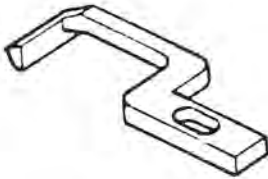

33250  
Needle Guard (Front)

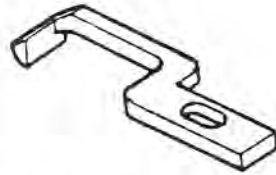

33089  
Needle Guard (Front)

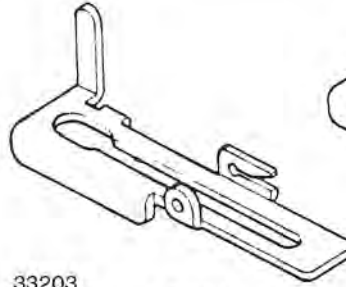

33203  
Thread Take-up Eyelet

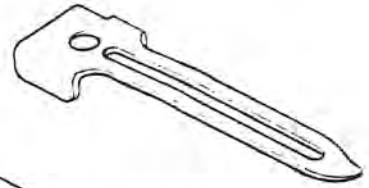

33205  
Thread Retaining Finger

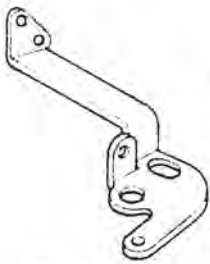

32959  
Looper Thread  
Pull-off



34224  
Looper Thread  
Pull-off

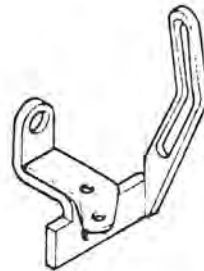

33167  
Needle Bar Thread  
Retainer Bracket



33081  
Double Chaining  
Looper Cellar

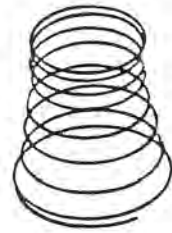

32952  
Looper Thread  
Tension Spring

FOR Z100-A2

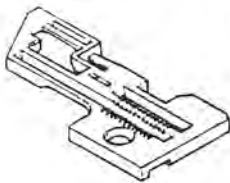

33568  
Stitch Plate

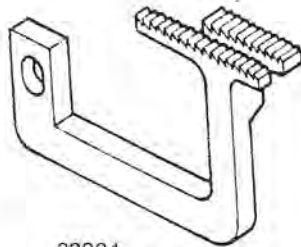

33824  
Differential Feed Dog

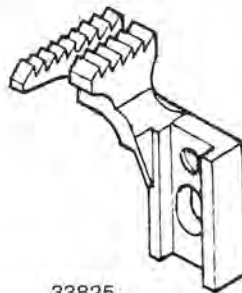

33825  
Main Feed Dog



33544  
Auxiliary Feed Dog

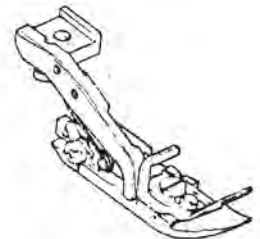

33537  
Presser Foot

FOR Z100-C5

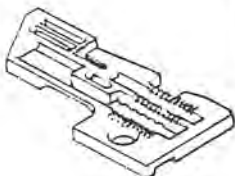

36590  
Stitch Plate

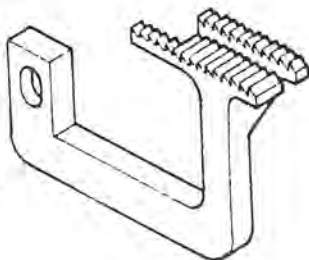

33828  
Differential Feed Dog

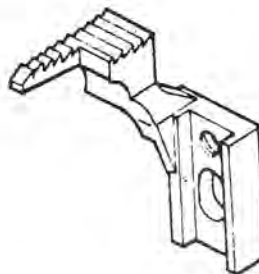

33829  
Main Feed Dog



33328  
Auxiliary Feed Dog

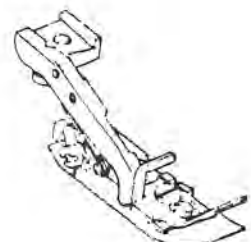

33539  
Presser Foot

# RICAMBI YAMATO

## FOR Z6000-C5

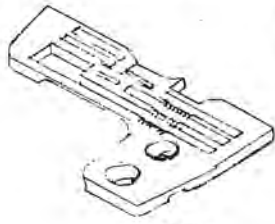

22012  
Stitch Plate

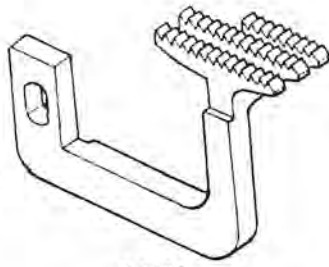

20460  
Differential Feed Dog

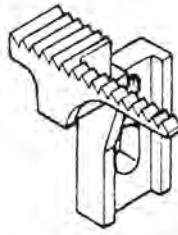

20461  
Main Feed Dog



20441  
Auxiliary Feed Dog

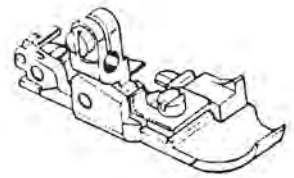

22131  
Pressere Foot

## FOR Z600-C6

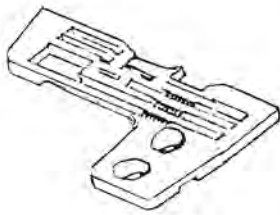

22075  
Stitch Plate

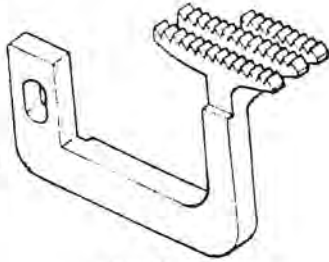

20460  
Differential Feed Dog

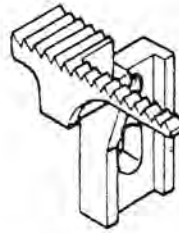

20461  
Main Feed Dog



20441  
Auxiliary Feed Dog

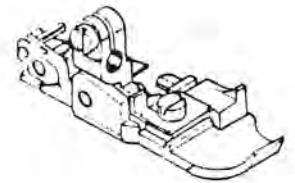

22133  
Presser Foot

## FOR Z6100-C5/C7

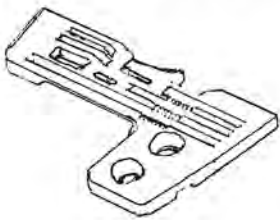

22220  
22235  
Stitch Plate

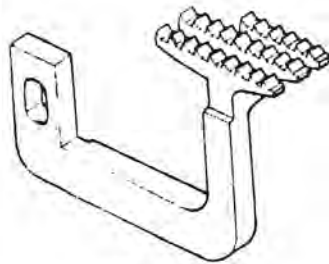

22222  
Differential Feed Dog

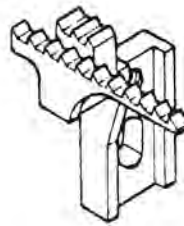

22223  
Main Feed Dog



20441  
Auxiliary Feed Dog

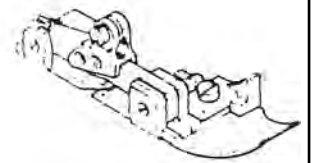

22230  
22218  
Presser Foot

## FOR Z5003-03/04

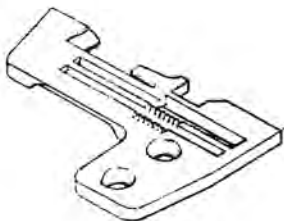

21768  
21769  
Stitch Plate

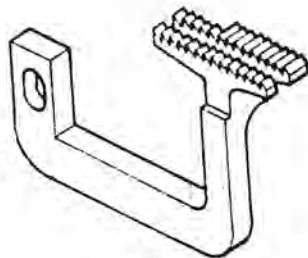

21846  
Differential Feed Dog

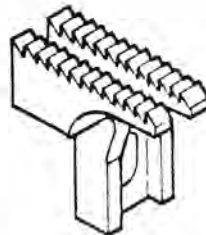

21842  
Main Feed Dog



21009  
Auxiliary Feed Dog

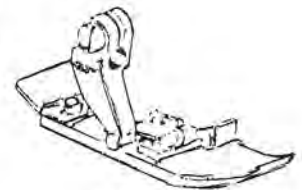

23000  
23001  
Presser Foot

## FOR Z5003-05

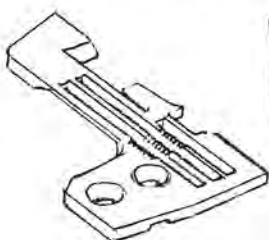

21774  
Stitch Plate

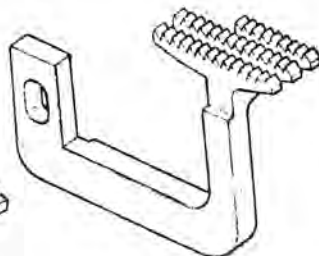

21847  
Differential Feed Dog

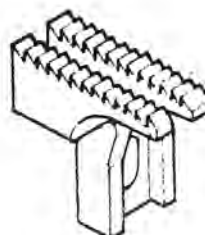

21842  
Main Feed Dog



21009  
Auxiliary Feed Dog



23002  
Presser Foot

# RICAMBI YAMATO

## FOR Z5020-X4

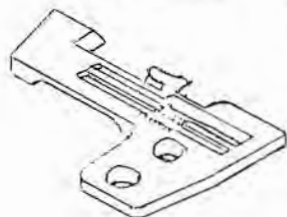

21781  
Stitch Plate

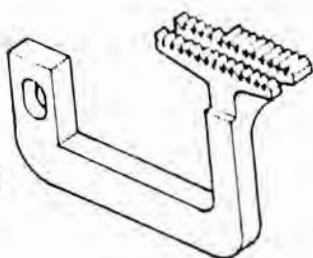

21846  
Differential Feed Dog

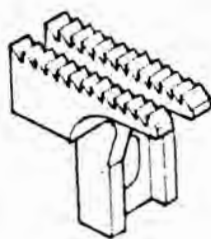

21842  
Main Feed Dog



21009  
Auxiliary Feed Dog

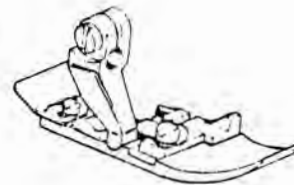

23030  
Presser Foot

## FOR Z5020-X5

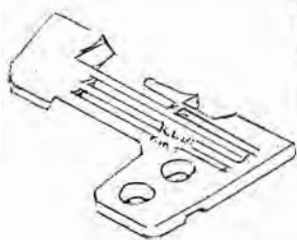

22601  
Stitch Plate

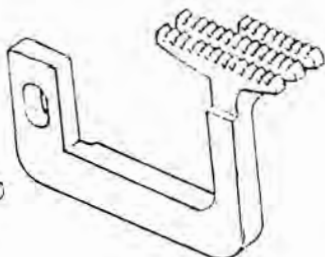

22608  
Differential Feed Dog

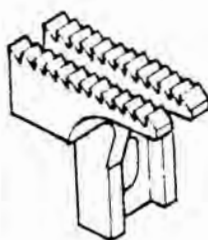

21842  
Main Feed Dog



21009  
Auxiliary Feed Dog



23032  
Presser Foot

## FOR Z-6000-A3/A4

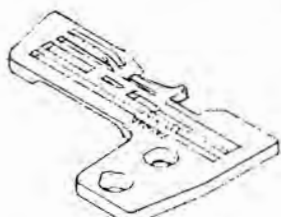

21800  
21801  
Stitch Plate

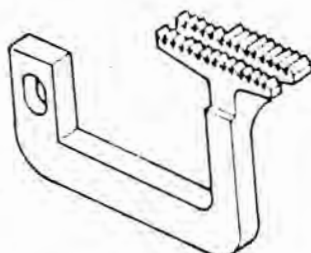

21846  
Differential Feed Dog

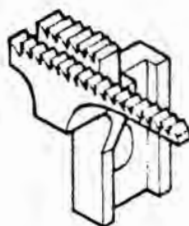

21848  
Main Feed Dog



20441  
Auxiliary Feed Dog

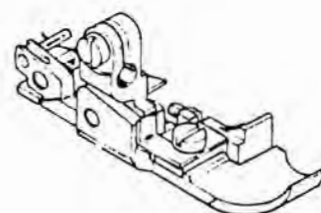

22085  
22087  
Presser Foot

## FOR Z-6000-A5/A6

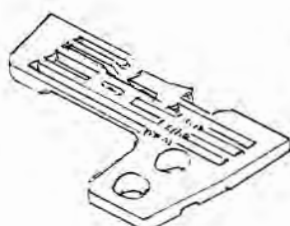

21812  
21813  
Stitch Plate

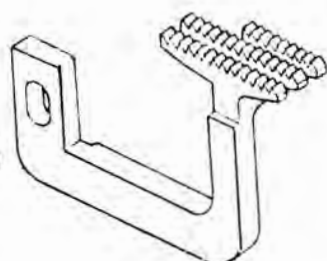

21847  
Differential Feed Dog

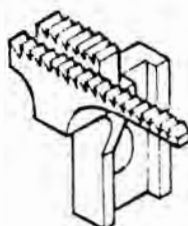

21848  
Main Feed Dog



20441  
Auxiliary Feed Dog

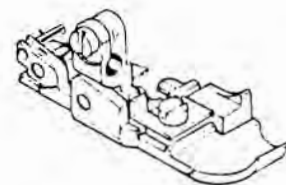

22089  
22091  
Presser Foot



Y2101133  
gruppo rientro  
catenella per  
YAMATO 8000



Y2121000 tagliacatenella  
YAMATO AZF8400

Disponibili inoltre:

Y2109906 (K1) orizzontale  
kl. AZ8500 - AZ8600 etc.

Y2109917 (K2) verticale  
kl. AZ8300 - 8000 - 6000 - 6003

tirante - bidone - venturi  
(vedi a pag. 140)

**RIEPILOGO LOOPERS YAMATO (importazione)  
la produzione MAIER è nelle pagine successive**

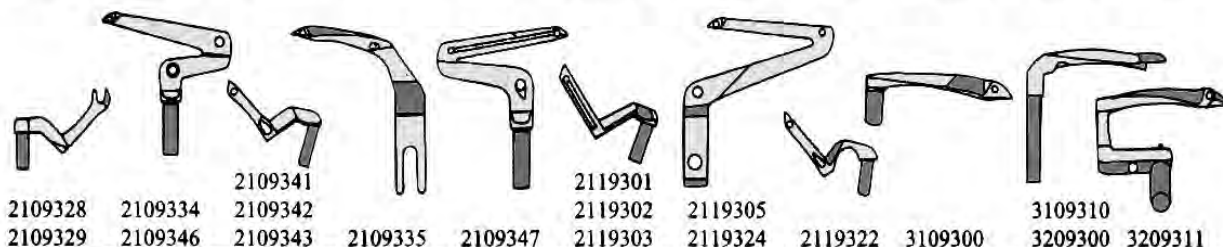
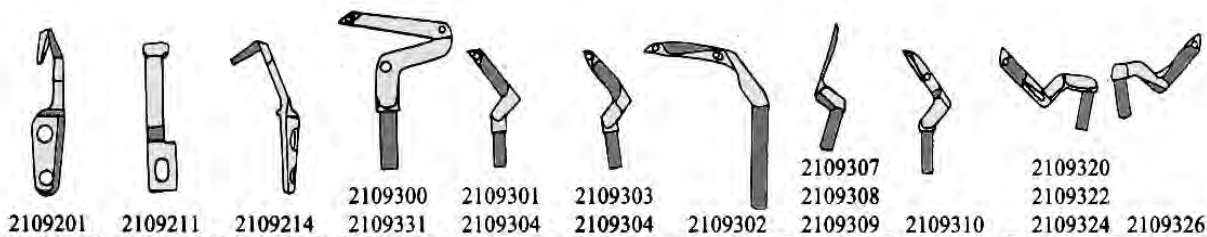
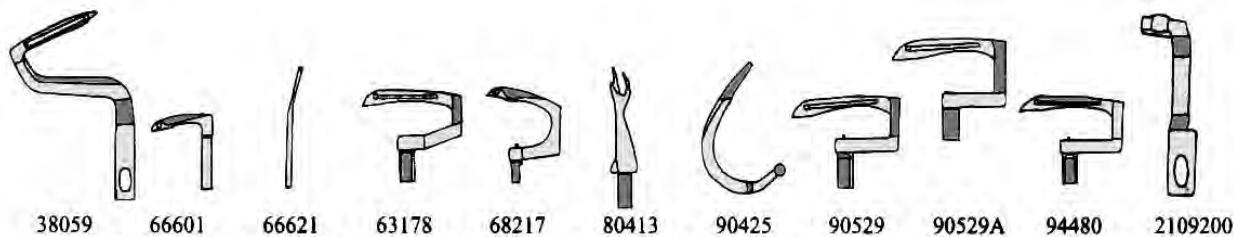
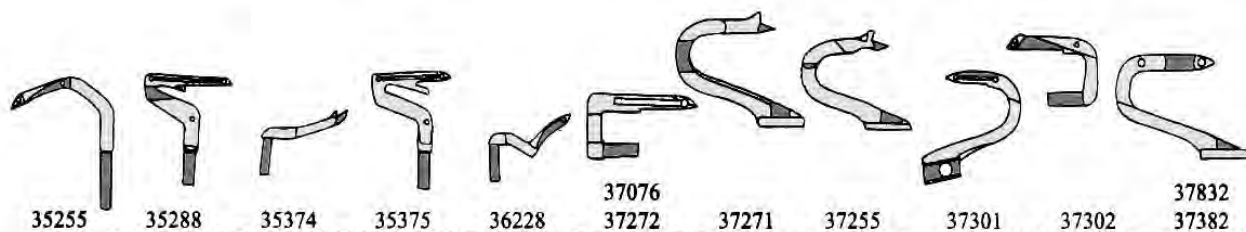
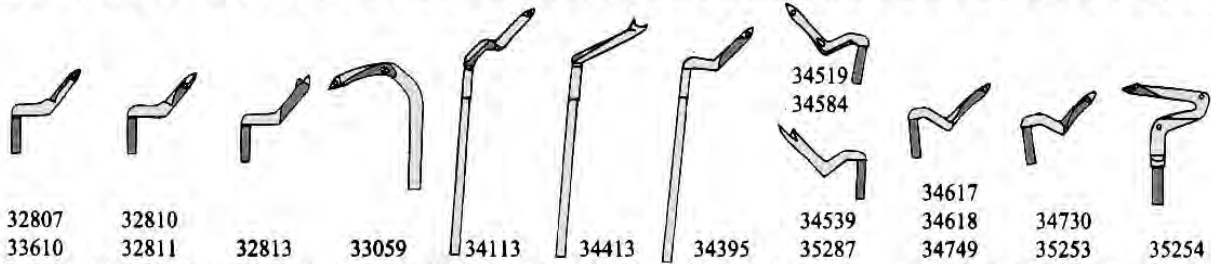

**Vi ricordiamo che su richiesta , siamo in grado di fornire anche ricambi originali di tutte le marche principali : in particolare, PFAFF – REECE –AMF STROBEL – MAUSER PEGASUS – JUKI - UNION SPECIAL – UNITAS – SIRUBA – KANSAI con listino ufficiale**

# RICAMBI YAMATO

## "K2" DEVICE

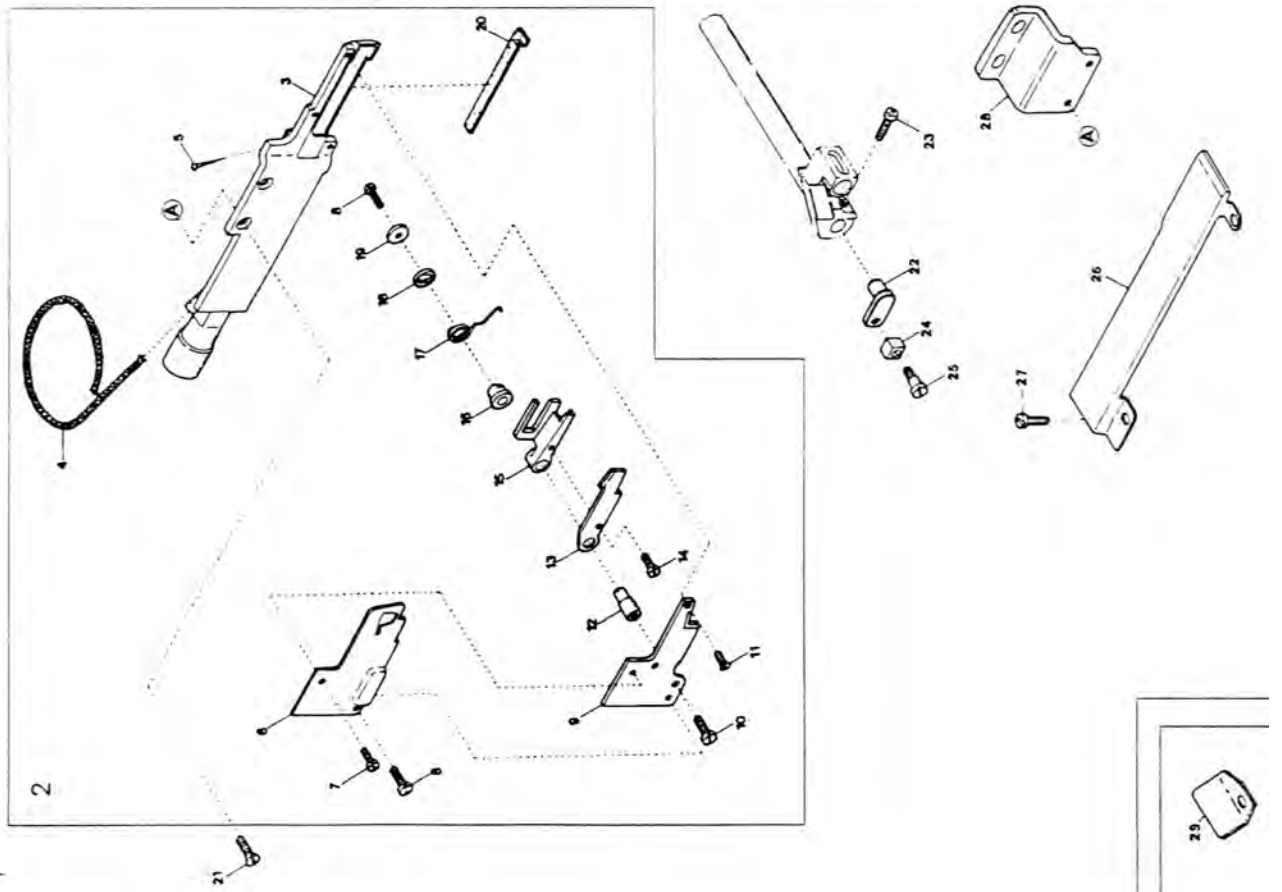

Ref. No.	Parts No.	Description	Am. Reg.
1	2109917	"K2" Device, Complete Set	1
2	2111050	Suction Pipe, Complete Set	1
3	2111051	Suction Pipe	1
4	310017	Oil Wick	1
5	000755	Oil Wick Pin	1
6	2111063	Suction Pipe Cover	1
7	004237	Screw (3/32-56X1.7)	1
8	004404	Screw (3/32-56X5.1)	2
9	2111055	Upper Trimming Knife	1
10	004131	Screw (1/8-44X6)	1
11	004139	Screw (3/32-56X3)	2
12	2111059	Lower Trimming Knife Holder Pin	1
13	2111056	Lower Trimming Knife	1
14	004236	Screw (3/32-56X4.2)	1
15	2111057	Lower Trimming Knife Driving Plate	1
16	2111062	Spring Sleeve	1
17	2111061	Lower Trimming Knife Pushing Spring	1
18	2111066	Spring Protect Washer	1
19	2111060	Washer	1
20	2111067	Air Shield Rubber	1
21	007623	Screw (9/64-40X5.3)	2
22	2111058	Lower Trimming Knife Guide Support	1
23	110068	Screw (M4-0.7x8)	1
24	2101011	Lower Trimming Knife Guide	1
25	270001	Screw (1/8-44X3)	1
26	2101059	Cloth Plate Spacer	1
27	110042	Screw (M3.5-0.6X4)	2
28	2101058	Suction Pipe Support	1
29	2107219	Presser Foot Chain Shield	1



# RICAMBI YAMATO

## "K1" DEVICE

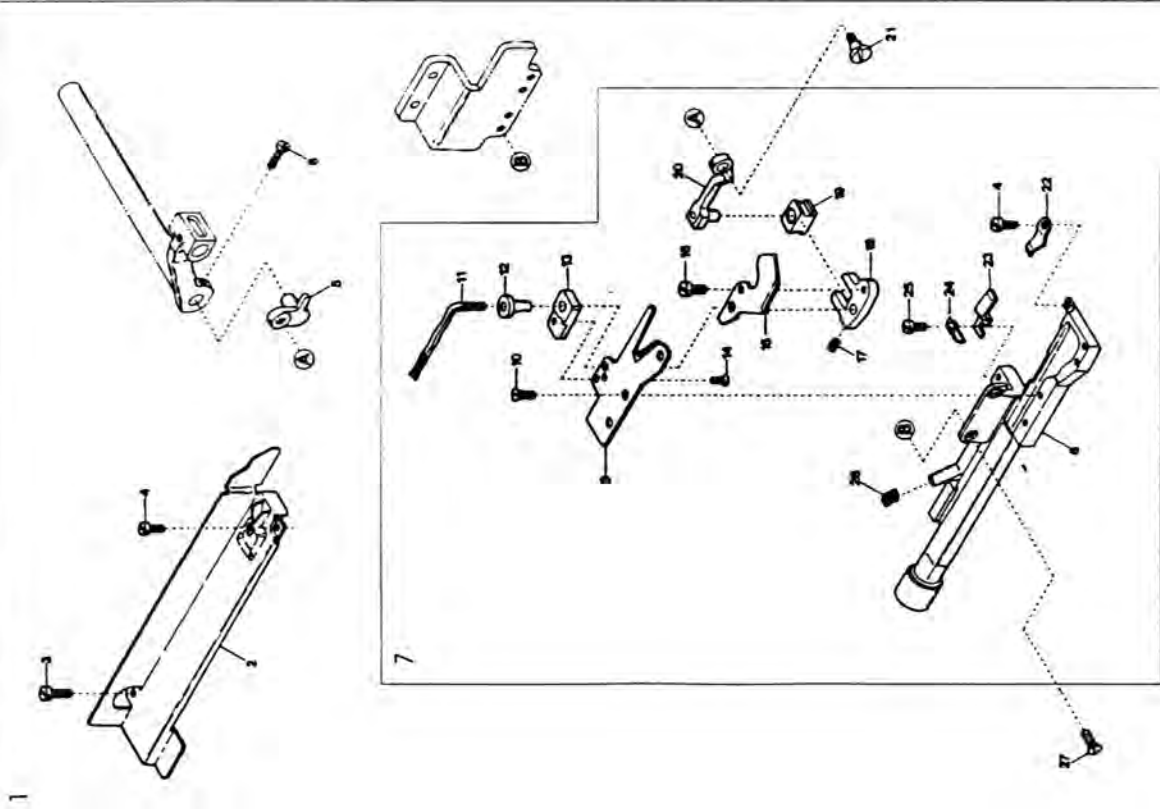

Ref. No.	Parts No.	Description	Am Reg
1	2109906	"K1" Device, Complete Set	1
2	2101167	Suction Pipe Cover	1
3	004314	Screw (1/8-44X5.6)	1
4	001230	Screw (3/32-56X3.8)	2
5	2101163	Lower Trimming Knife Driving Arm	1
6	110068	Screw (M4-0.7X8)	1
7	2101151	Suction Pipe, Complete Set	1
8	2101152	Suction Pipe	1
9	2101155	Upper Trimming Knife	1
10	005112	Screw (3/32-56X6)	2
11	000240	Oil Wick	1
12	2101160	Trimming Knife Holder Pin	1
13	2101161	Holder Pin Support	1
14	004139	Screw (3/32-56X3)	2
15	2101156	Lower Trimming Knife	1
16	110036	Screw (M3-0.5X6.5)	1
17	160001	Screw (M4-0.7X4)	1
18	2101157	Guide Block Holder	1
19	2101158	Lower Trimming Knife Guide Block	1
20	2101164	Lower Trimming Knife Driving Link	1
21	170010	Screw (M4-0.7X4)	1
22	2101159	Lower Trimming Knife Pushing Plate	1
23	2101166	Driving Link Presser	1
24	2101165	Oil Wick Clamp	1
25	001196	Screw (1/8-44X6)	1
26	310011	Felt	1
27	007623	Screw (9/64-40X5.3)	2

# RICAMBI YAMATO

## Parts for YAMATO VC2600/2700 series



0093170 (2ndl. 3.2mm)  
0093171 (2ndl. 4.0mm)  
0093172 (2ndl. 4.8mm)  
Needle plate



0094801 (3ndl. 5.6mm)  
0094802 (3ndl. 6.4mm)  
Needle plate



3109000  
3109002 (6.4mm)  
Diff. feed dog



3109001  
3109003 (6.4mm)  
Main feed dog



0063318 (2ndl. 3.2mm)  
0063319 (2ndl. 4.0mm)  
0063320 (2ndl. 4.8mm)  
Foot comp.



0064041 (3ndl. 5.6mm)  
0064042 (3ndl. 6.4mm)  
Foot comp.

### VC2603/2703



0094210 (2ndl. 3.2mm)  
0094211 (2ndl. 4.0mm)  
0094212 (2ndl. 4.8mm)  
Needle plate



0094901 (3ndl. 5.6mm)  
0094902 (3ndl. 6.4mm)  
Needle plate



3109018  
3109021 (6.4mm)  
Main feed dog



3109017  
3109022 (6.4mm)  
Diff. feed dog



0094215 (2ndl. 3.2mm)  
0094216 (2ndl. 4.0mm)  
0094217 (2ndl. 4.8mm)  
Foot comp.



0094908 (3ndl. 5.6mm)  
0094909 (3ndl. 6.4mm)  
Foot comp.

### VC2603-11/2703-11



0095234 (2ndl. 4.0mm)  
Needle plate

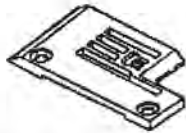

0095085 (3ndl. 5.6mm)  
Needle plate



3109021  
Main feeder



3109020  
Diff. feeder



0095238 (2ndl. 4.0mm)  
Foot comp.



0095089  
(3ndl. 5.6mm)  
Foot comp.

### VC2742P



0067035 (3ndl. 5.6mm)  
Needle plate



3109016  
Main feeder



3109015  
Diff. feeder



0067094  
Foot comp.



0066567  
Upper roller (rubber)

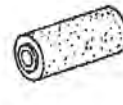

0067028  
Lower roller (rubber)



0095061  
Clutch



0065417  
Clutch roller

### Other parts



3109300  
Looper



3109200  
N. guard (Front)



3109201  
N. guard (Rear)



3109310  
Covering spreader

### VC2713



3009021 (3ndl. 5.6mm)  
Needle plate

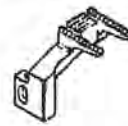

3109031  
Main feeder



3109030  
Diff. feeder



0094093  
Foot comp. (3ndl. 5.6mm)

## Parts for Yamato AZ8000 series

AZ8020, 8025, 8046



2109300  
Lower looper  
All classes



2109301  
Upper looper  
(needle #9 - 12)



2109303  
Upper looper  
(needle #13 - 16)



2109304  
Upper looper  
(needle #9 - 12)



2109305  
Upper looper  
(needle #13 - 16)

AZ8500



2109302  
Chain looper

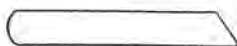

2100167  
Lower knife



0020491  
Upper knife















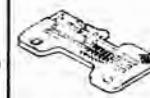



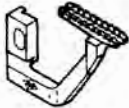

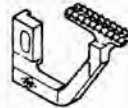
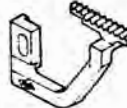













0020496  
Upper knife













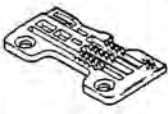
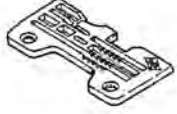



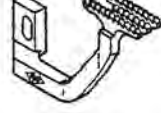
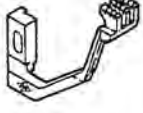
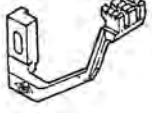

2109201  
Needle guard

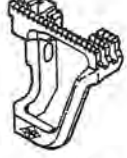
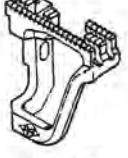





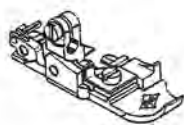
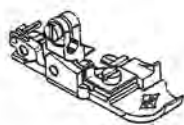
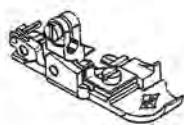
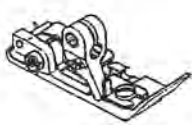
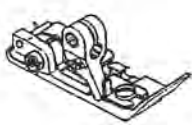
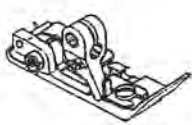
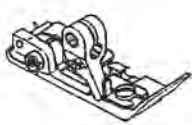











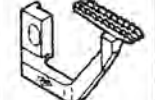

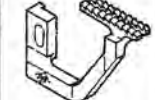
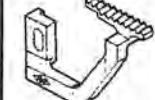









# RICAMBI YAMATO

GAUGE SET	AZ6003H-		AZ6000H-	AZ6016H-	AZ6020H-		AZ6025H-	
	03 (0X3)	04 (0X4) 05 (0X5) 06 (0X6)	03 (0X3) 04 (0X4)	02	Y5 (2.4X5) Y6 (2.4X6)	X4 (2.0X4) X5 (2.0X5)	Y5 (2.4X5) Y6 (2.4X6)	X4 (2.0X4) X5 (2.0X5)
Throat Plate	  2108002	  2108003 2108007 2108012	  2108001 2108000	  2108016	  2108004 2108005	  2108006 2108014	  2108004 2108005	  2108006 2108014
Diff Feed Dog	  2109007	  2109005 2109005 2109009	  2109000	  2109017	  2109005 2109009			
Main Feed Dog	  2109006		  2109001	  2109018	  2109006			
Aux. Feed Dog	  2109052			  2109019	  2109052			
Needle Clamp asm.	  2109132				  2109130	  2109131	  2109130	  2109131
Presser foot asm.	  2107300	  2107301 2107302 2107303	  2107031 2107032	  2107084	  2107310 2107311	  2107312 2107313	  2107077 2107078	  2107079 2107081













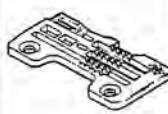
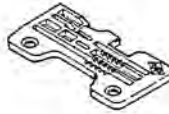

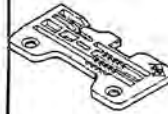

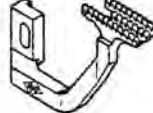
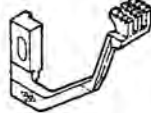
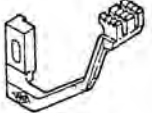
# RICAMBI YAMATO

GAUGE SET	AZ6500H-					AZ6505H-	
	A4 (3.2X4)	A5 (3.2X5)	A6 (3.2X6)	C5 (5X5)	C6 (6X6)	A4 (3.2X4)	C5 (5X5)
Throat Plate	 2108050	 2108051	 2108056	 2108052	 2108053	 2108050	 2108052
Diff Feed Dog	 2109050	 2109057	 2109055	 2109060	 2109062		
Main Feed Dog	 2109051		 2109056	 2109061	 2109063		
Aux. Feed Dog			 2109052				
Needle Clamp asm.		 2109120		 2109122		 2109120	 2109122
Presser foot asm.	 2107100	 2107124	 2107125	 2107102	 2107126	 2107147	 2107149

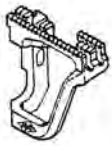





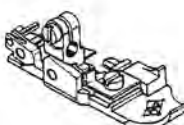
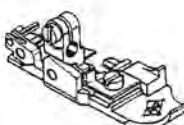
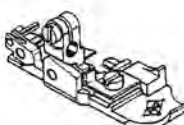
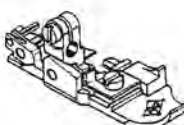
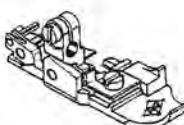
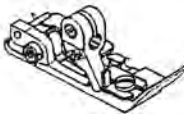
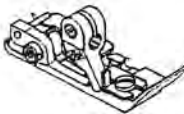



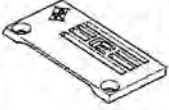
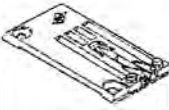
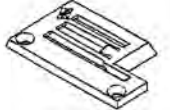



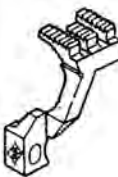

# RICAMBI YAMATO

GAUGE SET	AZ8003H-		AZ8000H-	AZ8016H-	AZ8020H-		AZ8025H-		
	03 (0X3)	04 (0X4) 05 (0X5) 06 (0X6)	03 (0X3) 04 (0X4)	02 (0X2)	Y5 (2.4X5) Y6 (2.4X6)	X4 (2.0X4) X5 (2.0X5)	Y5 (2.4X5) Y6 (2.4X6)	X4 (2.0X4)	
Throat Plate	  2108002	  2108003 2108007 2108012	  2108001 2108000	  2108016	  2108004 2108005	  2108006 2108014	  2108004 2108005	  2108006	
Diff Feed Dog	  2109007	  2109005 2109005 2109009	  2109000	  2109017	  2109005 2109009				  2109005
Main Feed Dog	  2109006		  2109001	  2109018	  2109006				
Aux. Feed Dog	  2109067		  2109019		  2109067				
Needle Clamp asm.	  2109100					2109101	2109102	2109101	2109102
Presser foot asm.	  2107300	  2107301 2107302 2107303	  2107031 2107032	  2107084	  2107310 2107311	  2107312 2107313	  2107308 2107309	  2107306	





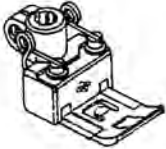

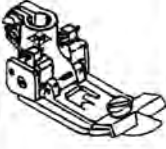
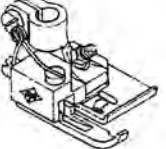

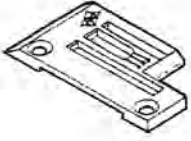
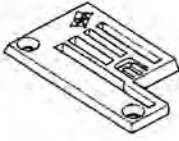
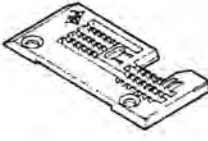
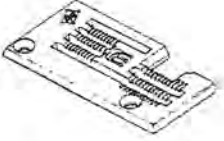

# RICAMBI YAMATO

GAUGE SET	AZ8500H-					AZ8505H-	
	A4 (3.2X4)	A5 (3.2X5)	A6 (3.2X6)	C5 (5X5)	C6 (6X6)	A4 (3.2X4)	C5 (5X5)
Throat Plate	 2108050	 2108051	 2108056	 2108052	 2108053	 2108050	 2108052
Diff Feed Dog	 2109050	 2109057	 2109055	 2109060	 2109062		
Main Feed Dog	 2109051		 2109056	 2109061	 2109063		
Aux. Feed Dog			 2109052				
Needle Clamp asm.	 2109110		 2109112	 2109110	 2109112		
Presser foot asm.	 2107100	 2107124	 2107125	 2107102	 2107126	 2107147	 2107149

# RICAMBI YAMATO



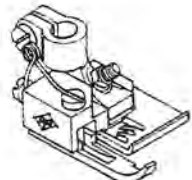
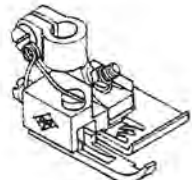
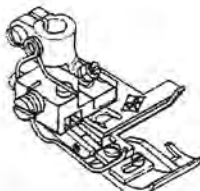
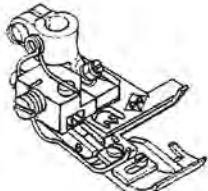

GAUGE SET	VF2400-		VF2500-		VF2403-		
	132M (232) 140M (240) 148M (248) 156M (256)	164M (264)	148M (348) 156M (356) 164M (364)	C (356)	132M (232) 140M (240) 148M (248) 156M (256)	164M (264)	140M-11 (240)
Throat Plate	 0093170 0093171 0093172 0093173	0093174	 0094800 0094801 0094802	 94801B	 0094281 0094282 0094283 0094284	0094285	 0095234
Diff Feed Dog	 3209001	3209003	 3209001 3209001 3209003	 3209001C	 3209005	3209007	 3209009
Main Feed Dog	 3209000	3209002	 3209000 3209000 3209002	 3209000	 3209004	3209006	 3209008
Needle Clamp asm.	 3209100 3209101 3209102 3209103	3209104	 3209106 3209107 3209108	3209107	 3209100 3209101 3209102 3209103	3209104	3209101
Presser foot asm.	 0095580 0095581 0095582	0095584	 0095586 0095587 0095588	 64041-N	 0094215 0094216 0094217	0094219	0095238

# RICAMBI YAMATO

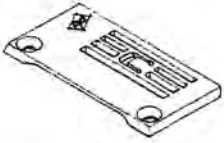
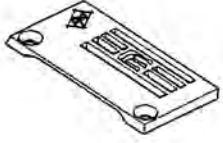
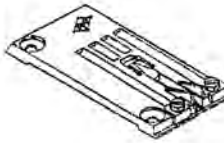
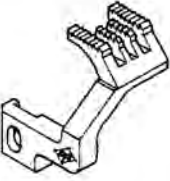
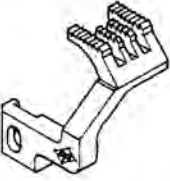
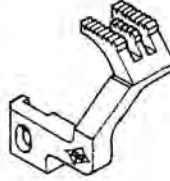
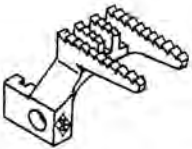
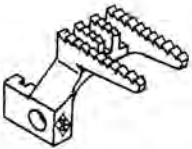

GAUGE SET	VF2503-		VF2409-	VF2509-
	156M (356) 164M (364)	156M-11 (356)	140M (240) 148M (248)	156M (356) 164M (364)
Throat Plate	 0094921 0094922	 0095085	 0095261 0095262	 0095278 0095279
Diff Feed Dog	 3209005 3209007	 3209009	 3209013	
Main Feed Dog	 3209004 3209006	 3209008	 3209012	
Needle Clamp asm.	 3209107 3209108	 3209107	 3209101 3209102	 3209107 3209108
Presser foot asm.	 0094908 0094909	 0095089	 0095314 0095315	 0095316 0095317

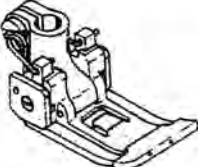
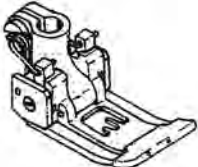

# RICAMBI YAMATO

GAUGE SET	VC2600-		VC2700-		
	132M (232) 140M (240) 148M (248) 156M (256)	164M (264)	148M (348) 156M (356)	164M (364)	C (356)
Throat Plate	  0093170 0093171 0093172 0093173	0093174	  0094800 0094801	0094802	  94801B
Diff Feed Dog	  3109000	3109002	  3109000	3109002	  3109030
Main Feed Dog	  3109001	3109003	  3109001	3109003	3109001
Needle Clamp asm.	  0093351 0093352 0093353 0093354	0093355	  0093356 0093357	0093358	0093357
Presser foot asm.	  0063318 0063319 0063320 0063321	0063322	  3107050 0064041	0064042	  64041-N

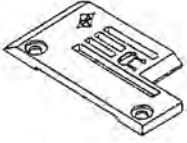
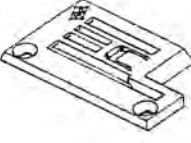
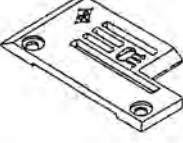
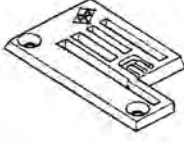
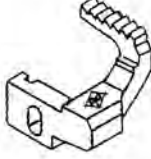
# RICAMBI YAMATO

GAUGE SET	VC2603-			VC2703-	
	132M (232) 140M (240) 148M (248) 156M (256)	164M (264)	140M-11 (240)	156M (356) 164M (364)	156M-11 (356)
Throat Plate	 0094210 0094211 0094212 0094213	0094214	 0095234	 0094901 0094902	 0095085
Diff Feed Dog	3109017	3109022	 3109020	3109017 3109022	3109020
Main Feed Dog	3109018	3109021	 3109021	3109018 3109021	3109021
Needle Clamp asm.	0093351 0093352 0093353 0093354	0093355	0093352	0093357 0093358	0093357
Presser foot asm.	0094215 0094216 0094217 0094218	0094219	0095238	0094908 0094909	0095089