

# RICAMBI UNION SPECIAL

cl. 35800

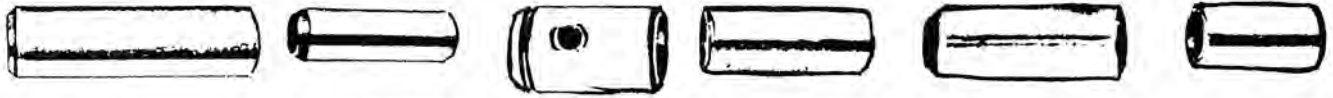

# 35731 F (bronzo)

# 35859 K (35759 A)  
bronzo

# 35760 E (bronzo)

# 35831 G (bronzo)

# 35850 D (bronzo)

# 35859 L (35859 B)  
bronzo



# 35848 B



# 35848 D



# 35848 E



# 22562 A



# 22564 D

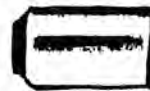

# 35859 C (bronzo)



# 35859 D (bronzo)



# 35818 BY-9  
(9 gauge)



# 605



# 35825 E



- # 35817 E



# 35796 B



# 35796 C



# 35870



# 35864 F



# 35830 K



# 35763 F - 625



# 35820 BQ-9  
(9 gauge)

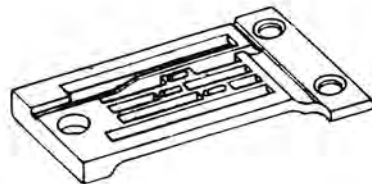

- # 35824 BQ 9 (9 gauge)

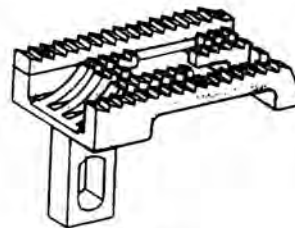

# 35805 BQ 9  
(9 gauge)



# 35826 E



35830 BX-8  
35830 BX-9  
35830 DM-9

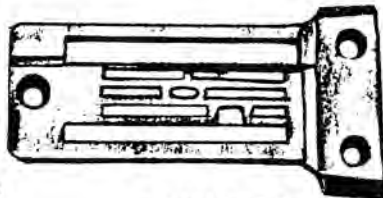

- # 35824 DQ-9 (9 gauge)

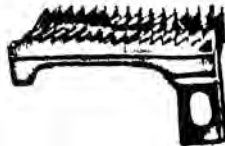

- # 35805 BR 8  
(8 e 9 gauges)  
- # 35805 DP 8  
(8 e 9 gauges)



- # 35826 DP  
(8 gauge)  
- # 35826 DM  
(9 gauge)



- # 35826  
(8 e 9 gauges)



35820 AC-16

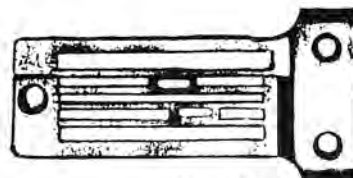

- # 35824 AC-16



- # 35805 AC-16

cl. 35800 AC

# RICAMBI UNION SPECIAL

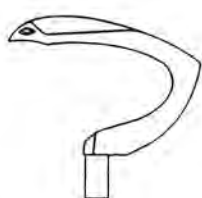

35809AY (AV)

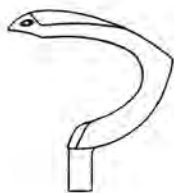

35809BY (AY)



35808 AY (AU)

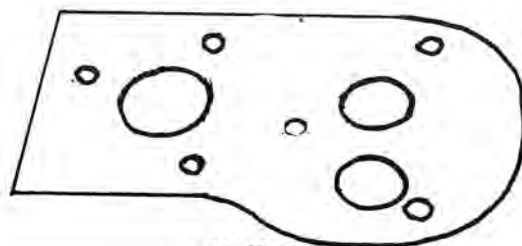

- # 35887 AD

## cl. 36200

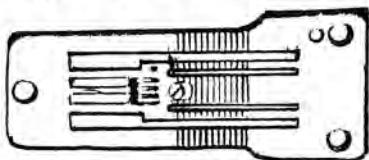

# 36224 A



# 36205 A

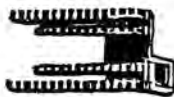

# 36226 A

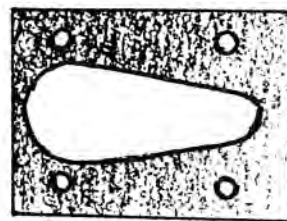

- # 35884 D

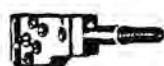

# 36218



# 36210



# 36248



# 22652 A 6



- # 36204



# 36279 C



- # 36249



# 36283 B



# 36237 F



# 36232 F - destro



# 36231 F - sinistro



# 36231 G



# 36232 G



# 36234 C



36251 E (A)

# 36232 Z (36232 E)  
destro, allungato

# 36231 Z (36231 E)  
sinistro, allungato

# 36232 D  
destro, corto

# 36231 D  
sinistro, corto



36270 HSS



CT 36270



36250 HSS



CT 36250



36240



G 36240



36208 A



G 36208 A



# 36230 D

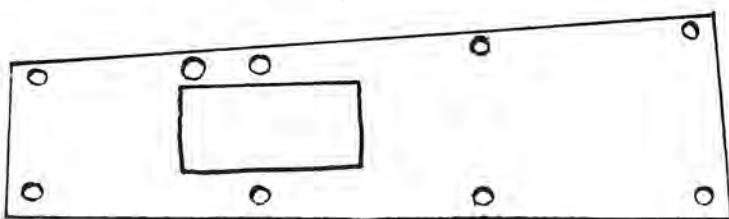

# 36283 F



36251 F



K 73512 (D)

# RICAMBI UNION SPECIAL

## cl. 39200

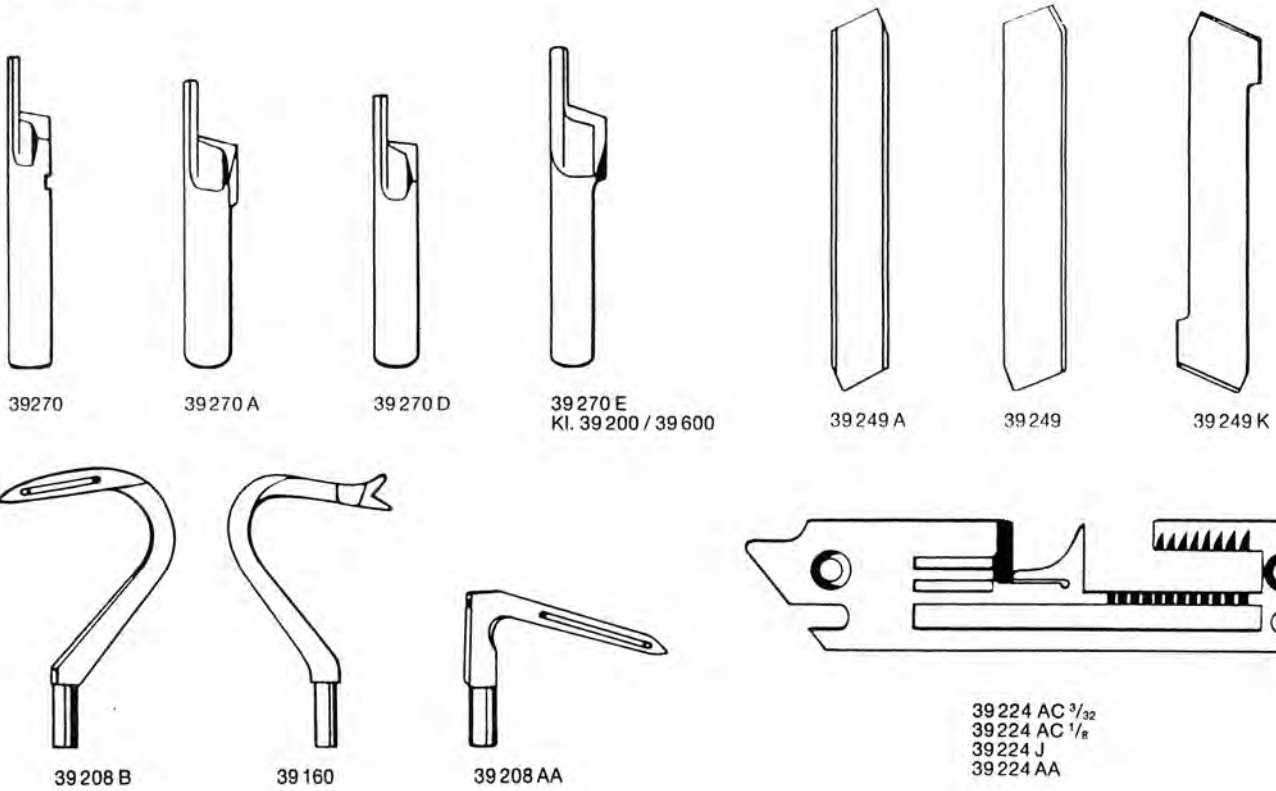

## cl. 39500

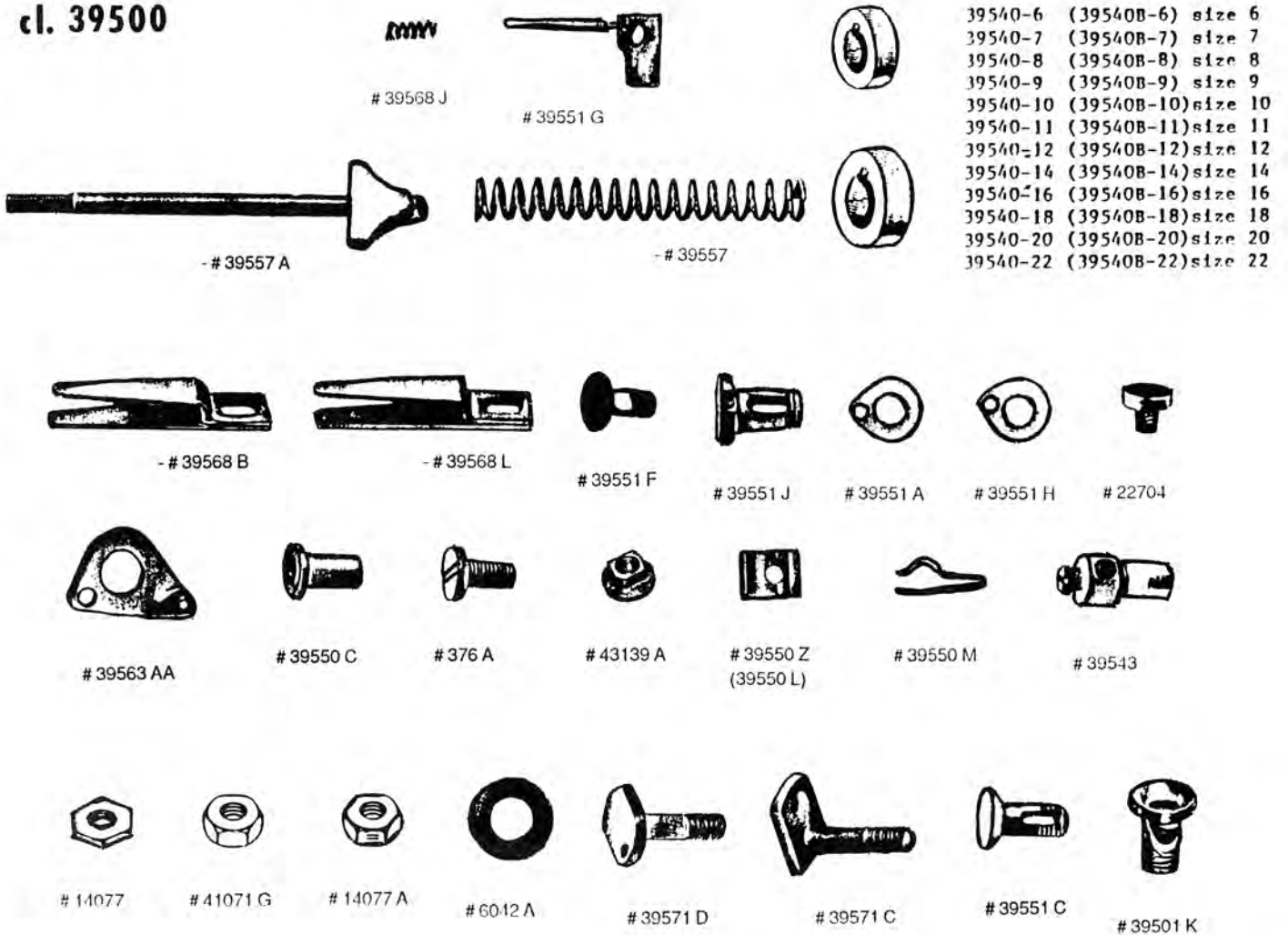

# RICAMBI UNION SPECIAL

cl. 39500



#99672

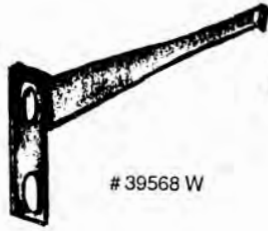

#39568 W



#39663 A



#39563 H



#39563 F



#39534



#39534 G



#39536 Z



#39536 C



- #39536 A  
- #39536 AE



#39541 A



#39538



#39536 B



#39535 B  
(39535 J)



#39568 E



#39552 AD



- #39563 G



- #39525 M



- #39525



- #39525 A



- #729



- #39525 N (39525 P)



- #39572



- #39572 A



- #39571 B



- #39550 E



#39563 W



#21227 BF

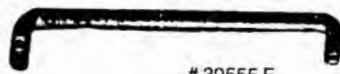

- #39555 F



- #35792 H



#109 D



#39571 F



#39543 M



- #39543 K



#39568 A



#39557 E



#39557 B



#39556 F



#39592 AD



- #51292 F-1 tens. crochet  
- #51292 F-4 tens. crochet  
- #51292 F-5 tens. ago  
- #51292 F-8 tens. ago

# RICAMBI UNION SPECIAL

cl. 39500



# 39521 PA



# 39594 H



# 39594 N



# 9593 C



- # 29481 H



# 39592 AF



# 39592 AH



# 39592 AL



# 8372 A



# 39592 AR-8  
(39592 AE-8)



# 39543 T



- # 29481 J



- # 39578 R

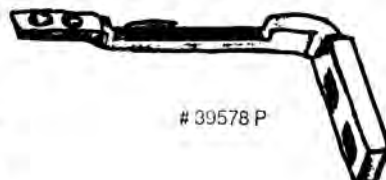

# 39578 P



# 22569 B



# 8372 A



39578 T

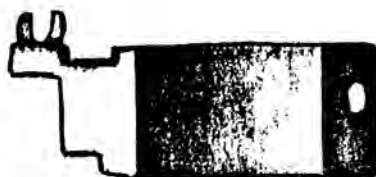

39578 U



# 51295 A



# 51295 B



- # 39532 A



- # 39582 AE

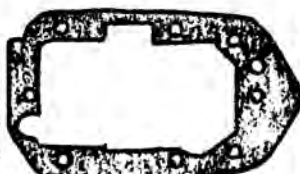

- # 39582 A

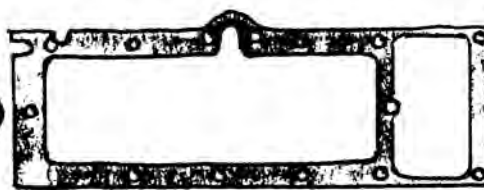

# 39582 Y

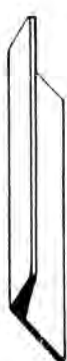

G 39 570

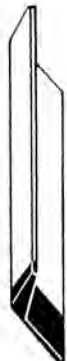

CT G 39 570



39 570 SC  
Solid carbide  
Metal sólido duro

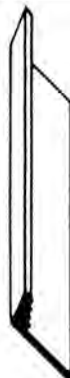

G 39 570 A  
(A 9181)



A 9392  
(CT)



G 39 570 JU  
(A 9259)



CT G 39 570 JU

# RICAMBI UNION SPECIAL

cl. 39500



39570 J



CT 39570 J



39570 K

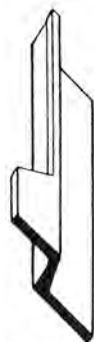

39570 L



39556 K



39556 G



39549



G 39549 N  
(A 9393)  
(CT)



39549 SC  
Solid carbide  
Metal sólido duro



G 39549 JU  
(A 9071)



G 39549 SU  
(CT)



39549 J



CT 39549 J

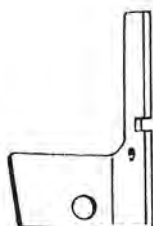

99669 K (GM)

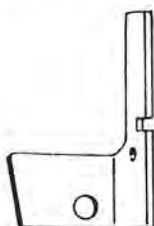

CT 99669 K (GS)  
CT 99669 KH

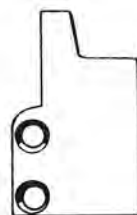

99670 L



99669 (GC)



CT 99669

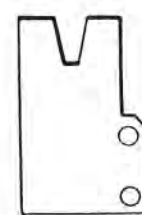

99670 (GD)



39508 A (CC)  
G 39508 A (UM)



39508 E (CK)



G 39508 AV (GC)  
(A 9050)

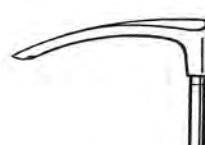

39508 C



39560 A (E)

# RICAMBI UNION SPECIAL

cl. 39500



39508 B



39508 D



39508 P



39560 B

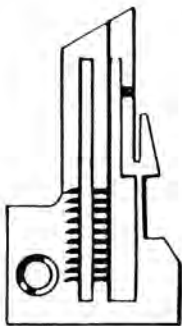

39524 B  $\frac{3}{32}$   
(V  $\frac{3}{32}$ )

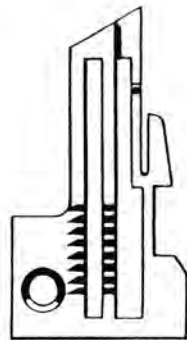

39524 B  $\frac{1}{8}$   
(V  $\frac{1}{8}$ )

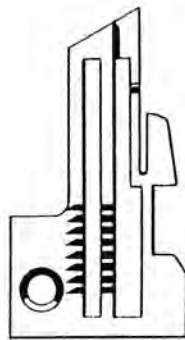

39524 B  $\frac{5}{32}$   
(BH)

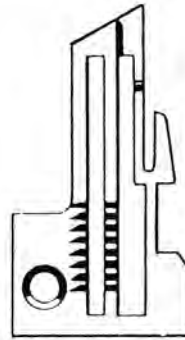

39524 P  
(A.J)

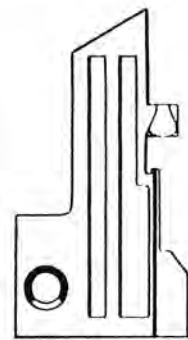

39524 GA  
(A 8924)

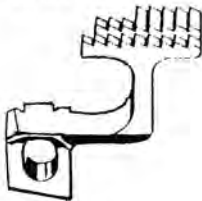

39526 AW

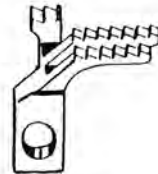

39505 AW



39505 B

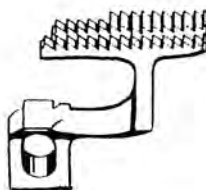

39526 B

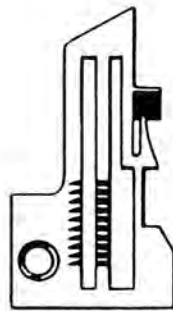

39524 C  $\frac{3}{32}$   
(AC  $\frac{3}{32}$ )

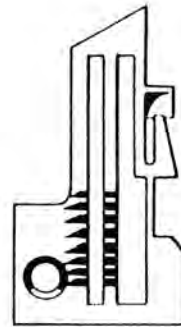

39524 C  $\frac{1}{8}$   
(AC  $\frac{1}{8}$ )

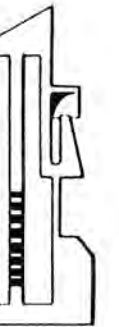

39524 C  $\frac{5}{32}$   
(AC  $\frac{5}{32}$ )

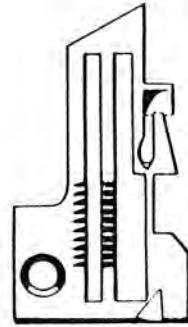

A 9953  $\frac{1}{8}$   
(HV  $\frac{1}{8}$ )



39505 E

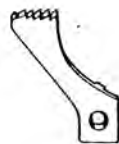

39505 C

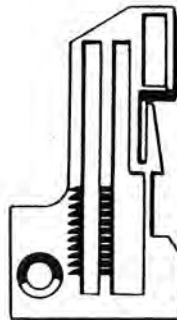

GA 39524 C  $\frac{3}{32}$  (HA)

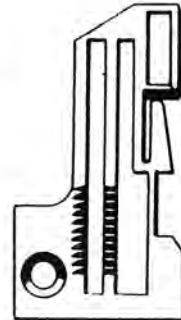

GA 39524 C  $\frac{1}{8}$  (HB)

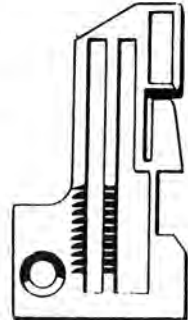

GA 39524 C  $\frac{5}{32}$  (HC)

# RICAMBI UNION SPECIAL

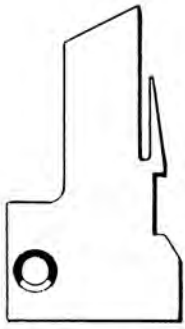

39 524 AB 1/8  
(AX 1/8)  
ohne Transporteurschlitz

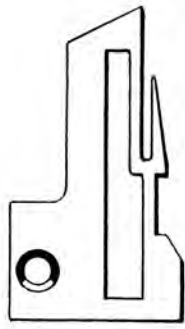

39 524 AB 1/4  
(AX 1/4)

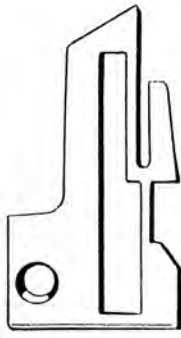

39 524 AB 5/32  
(AX 5/32)

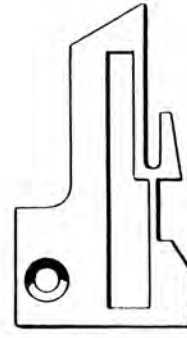

39 524 AC (AV)

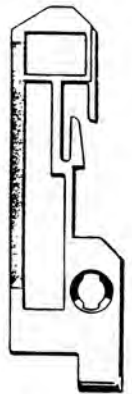

A 9608 B (HG)

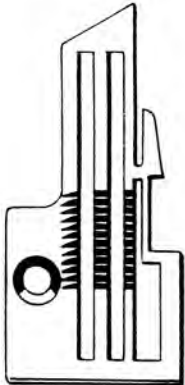

39 524 BF 1/8 (BK)

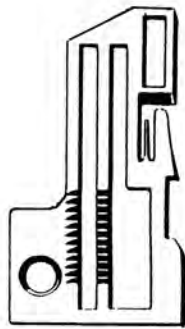

G 39 524 AV (GB)

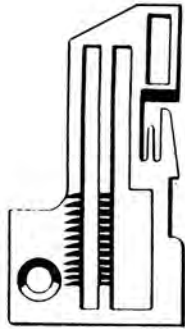

G 39 524 AW (GC)  
GB 39 524 AW (HN)

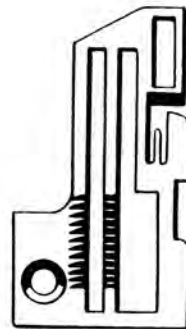

GA 39 524 AW (HH) 5/32

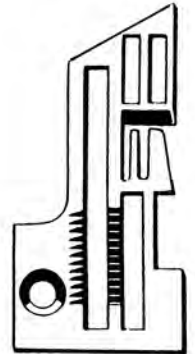

39 524 W (AN)

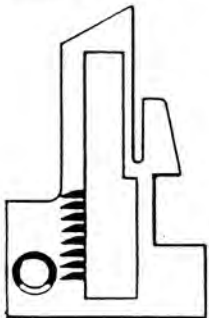

39 524 J

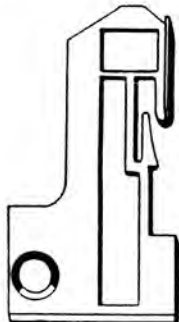

G 39 524 JU  
(GI)

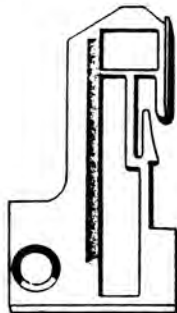

GA 39 524 JU  
(HE)

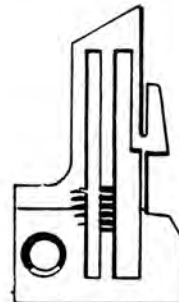

39 524 D (AM)

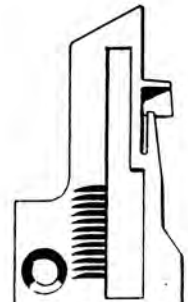

39 524 AS (BE)

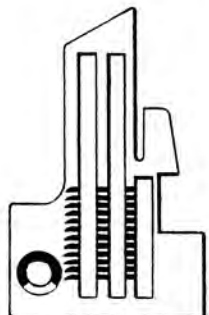

39 524 N (AH)



- # 39 526 AC  
completa



# 39 526 AC



# 39 505 P (J)



# 39 526 AA (AA)



# 39 505 E



# 39 505 F (F)



# 39 526 H



# 39 505 H (U)



# 39 505 S (R)



# 39 526 U (P)



- # 39 505 J/K  
completa



# RICAMBI UNION SPECIAL



- #39524 Y 1/8" (AS)



- #39524 T (AL)



#39520 T



# 39520 P



# 39505 P (J)



# 39526 Y (AB)



# 39505 P (J)



# 39526 P



#39520 W



#39597 W



# 39505 E



39520 N



# 39520 A



#39520 B

## FOR 39800AP, AQ

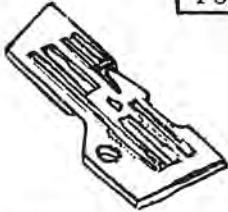

39828A-12-3/16  
Throat plate



39826A  
Diff. feeder



39826C  
Diff. feeder



39805A-12-3/16  
39805B-12-3/16  
Main feeder

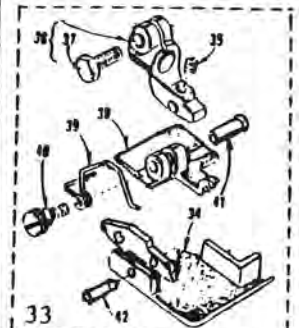

- 33 39820A-12 3/16 Presser foot.
- 34 39830C Foot bottom.
- 35 22733 Set Screw
- 36 39830 Foot shank.
- 37 22588A Clamp screw.
- 38 39830A Needle hole section.
- 39 39830S Spring.
- 40 39830F Hinge screw.
- 41 39830B Locknut screw.
- 42 39830E Hinge pin.

## FOR 39800 AX, AY

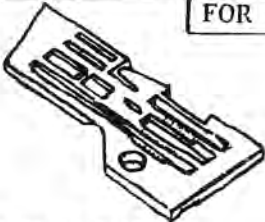

39828E-12-3/16  
Throat plate



39826A  
Diff. feeder



39826C  
Diff. feeder



39805E-12-3/16  
Main feeder

## FOR 39800 AA, AB, AP, AQ

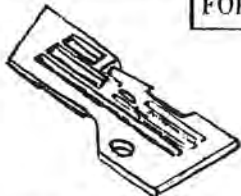

39828G-5-1/8  
Throat plate



39626D  
Diff. feeder



39805G-5-1/8  
Main feeder



39820 A-5 1/8  
Presser foot

## Separate parts for 39820A-5-1,

- 34 39830K Foot bottom.
- 36 39830G Foot shank.
- 38 39830H Needle hole section
- 41 39830J Locknut screw.



39808A



39808C

39808



39808D



39860

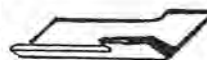

39870

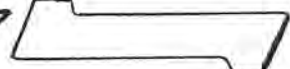

39849

# RICAMBI UNION SPECIAL

## GAUGE SETS FOR 51400 BP



51420-8 (1/8" Gauge)  
51420-12 (3/16" Gauge)  
51420-16 (1/4" Gauge)  
Presser Foot with Channels

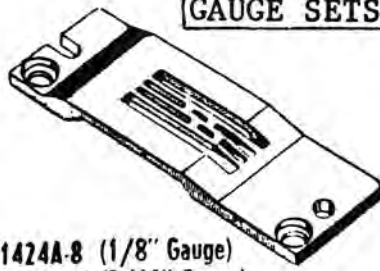

51424A-8 (1/8" Gauge)  
51424A-12 (3/16" Gauge)  
51424-16 (1/4" Gauge)  
Throat Plate



51405A-8 (1/8" Gauge)  
51405A-10 (3/16" Gauge)  
51405-16 (1/4" Gauge)  
Feed Dog,



51420C-8 (1/8" Gauge)  
51420C-12 (3/16" Gauge)  
51420C-16 (1/4" Gauge)  
Presser Foot with Flat Bottom

## GAUGE SETS FOR 51400BX



51420K-24 (3/8" Gauge)  
Presser Foot with Flat Bottom

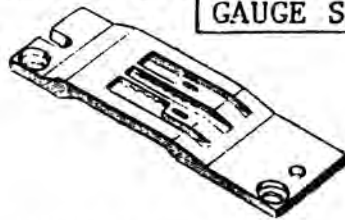

51424K-24 (3/8" Gauge)  
Throat Plate



51405K-26 (3/8" Gauge)  
Feed Dog

## BACK LOOPERS



51409



51409B

## FRONT LOOPERS

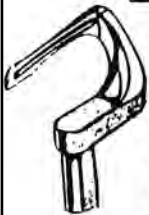

51408-8 (1/8" Gauge)  
51408-12 (3/16" Gauge)  
51408-16 (1/4" Gauge)  
51408-24 (3/8" Gauge)  
51408-32 (1/2" Gauge)

## For 51700



51709



51708

## LAP SEAM FOLDER



23420V-3/16M 23420V-1/4M  
23420V-3/16MH 23420V-1/4MH  
23420V-3/16H 23420V-1/4H  
23420V-3/16XH 23420V-1/4XH

## GAUGE SETS FOR 51800

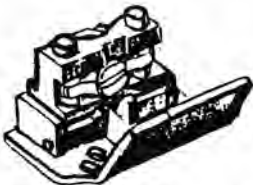

51820-16-64-16 Presser Foot  
51820-12-56-12

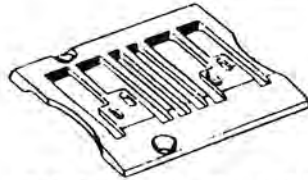

51824-16-64-16 Throat Plate  
51824-12-56-12



51805-16-64-16 Feed Dog  
51805-12-56-12

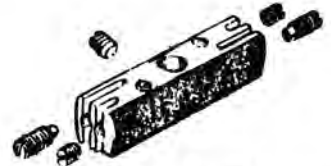

51818-16-64-16 Needle Holder  
51818-12-56-12

## GAUGE SETS FOR 51900 BH



35820P-9  
Presser Foot



51924B-9  
Throat Plate



51905B-9  
Feed Dog

## LOOPERS



51808 Front



51809 Back



51808A Front

## GAUGE SETS FOR 51900 BJ



35820R-9  
Presser Foot

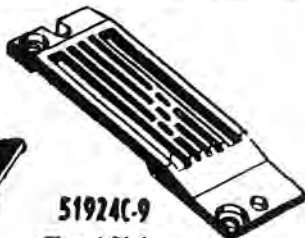

51924C-9  
Throat Plate



51905C-9  
Feed Dog

## LOOPERS



51908B-9  
Front



51909C  
Middle



51909D-9  
Back

# RICAMBI UNION SPECIAL

52700, 52800, 52900  
57700, 57800

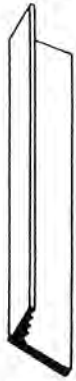

52970 E



A 9464 = 52970 D  
(CT)



52949 A



CT 52949 A



52949



52970 C



CT 52970 C

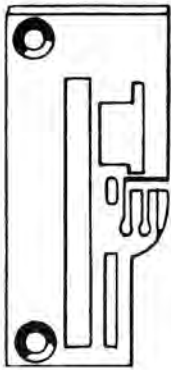

G 52928 A 5-8

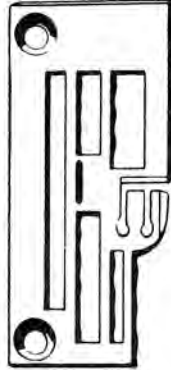

52928 A 16-8

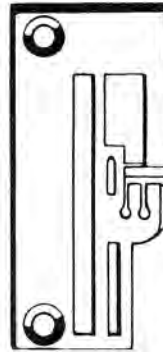

52924 BH 5-8

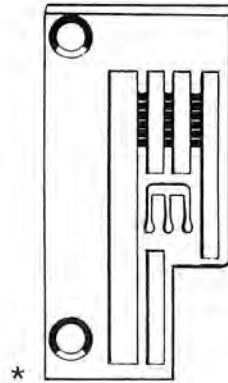

\* C 52824 N-16

52700



52770 C (B)  
52770 D (E)  
CT 52770 C



52749 A

52700 BKZ Galkin

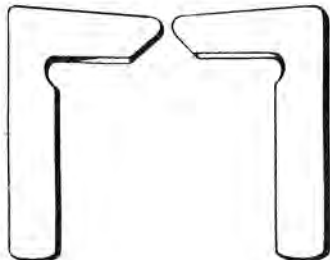

167 L  
CT 167 L



168 R  
CT 168 R

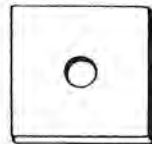

169

51400, 52300, 52900, XF 500

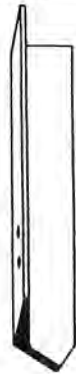

51470



J



CT 51449

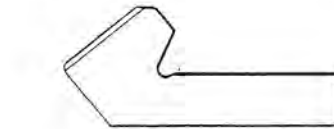

A 9540

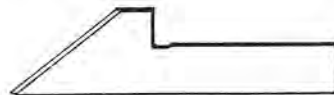

52949 B

54200, 54400



\*

54208 B



54211 A

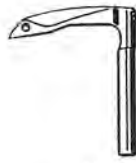

54208 (BZ)

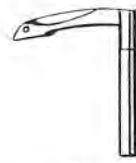

54208 A (CB)

53100



G 53170 R



9949 AR

# RICAMBI UNION SPECIAL

## 52800 BA, BD, BP, BR, BS, BY, BU, BV



13120F-8  
Presser foot



52820H-8  
52820H-12  
Presser foot

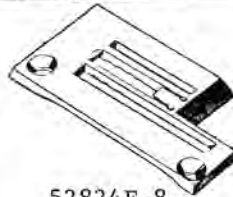

52824F-8  
52824F-12  
Throat plate



5026A  
Diff. feeder



52805F-8  
Main feeder

## 52800BW



52820K-16  
Presser foot

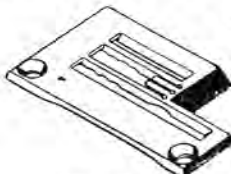

52824K-16  
Throat plate



52826K  
Diff. feeder



52805K  
Main feeder

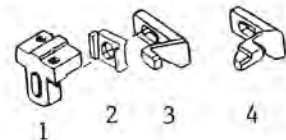

- 1 52853 Feed dog holder
- 2 52925D Needle guard holde
- 3 52825B Rear needle guard
- 4 52825A Rear needle guard
- 52825E Rear needle guard

## 52800BX



52820X-16  
Presser foot



52824X-16  
Throat plate



52826H  
Diff. feeder



52805X-16  
Main feeder

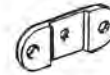

23432  
Folder clamp



52864N  
Folder suppor  
bracket

## 52800BN



5127H  
(G52827-16)  
Presser foot

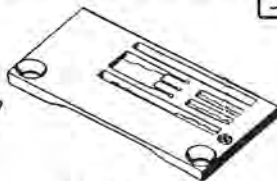

52824D-16  
Throat plate



3026A  
Diff. feeder



52805D-16  
Main feeder



56958 (51958)  
Needle lever  
thread eyelet



56958A (51958)  
Needle bar  
thread eye

## OTHER PARTS FOR 52800, 57800

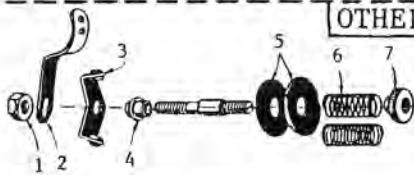

- 1 43266 Nut
- 2 51491C Thread lead-in guide
- 3 51292D Tension thread eyelet
- 4 51292A Tension post ferrule
- 5 109 (109D) Tension disc
- 6 51292F-1, 2, 4, 5, 8,  
Tension spring
- 7 51292C Tension nut

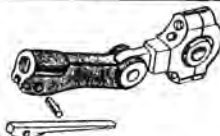

52941F  
Looper connecting rod  
section and ball joint  
assembly, Right



52804A (52804)  
Cast off plate, Wire



51458 (56458A)  
Needle bar  
thread eyelet



158B  
Thread guide

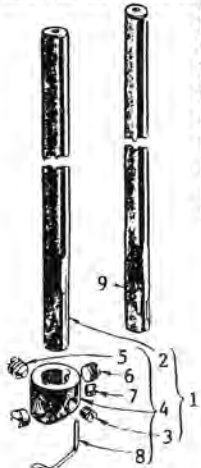

- 1 29264S-16 N.bar assembly
- 2 52817-16 Needle bar only
- 3 28C Screw
- 4 52818-8 Needle clamp
- 5 89 Screw, spot
- 6 88B Screw, needle
- 7 52842G Thread guide, wire
- 8 28B Screw
- 9 52817E-8 Needle bar only
- 52717E-12 Needle bar only



52708B  
Looper



52845A  
Spreader



51758  
Thread guide



52904G  
Cast off, Wi

# RICAMBI UNION SPECIAL

## 53100B, C

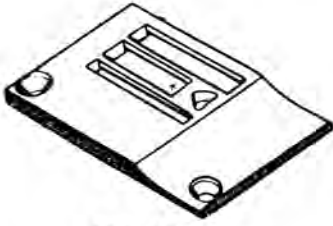

53124B  
Throat plate



53105B  
Feed dog



53108C  
Looper assembly



53117A Needle bar  
56N (56) Needle clamp nut



79220A  
Presser foot

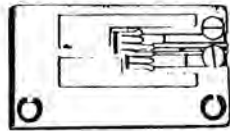

79228A Throat plate

79230H Stitch tongue, center  
79230G Stitch tongue, left  
79230D Stitch tongue, right

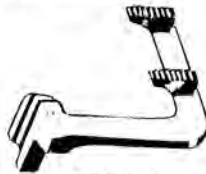

53426A  
Diff. feeder



53405A  
Main feeder

## 53400

## LOOPERS

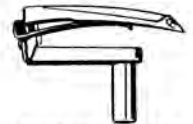

53407C(53407)  
Front looper

53411B  
Thread retainer spring

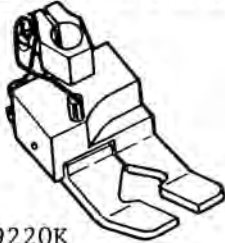

79220K  
Presser foot

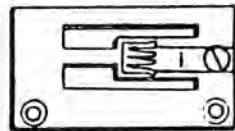

79224K Throat plate

79230K Stitch tongue

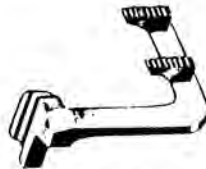

53426K  
Diff. feeder



53405K  
Main feeder



53409C(53409)  
Rear looper

53411C  
Thread retainer spring

## OTHER LOOPERS

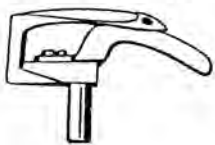

52808E



52908B

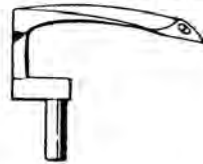

52909A

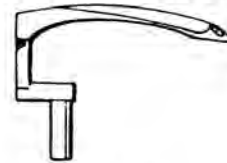

52909E-16



51909C(51909B)



51509C



51508-16  
(51508M-16)



51508-18  
(51508M-18)



51208



51208Y



51409C

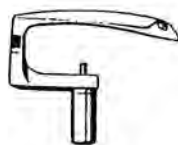

52708B



52708A



5107H



33709A



9907



2108



AS26XA











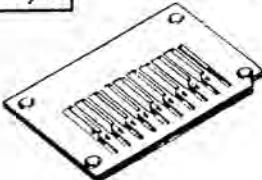

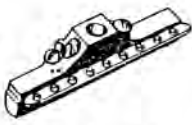

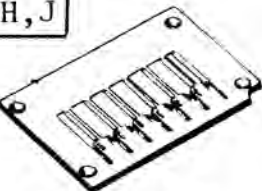



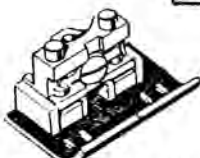
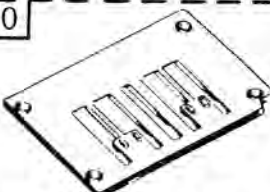

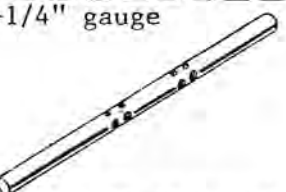
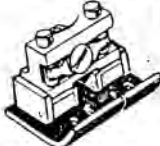
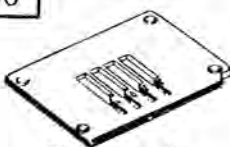

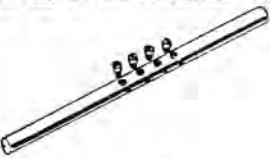















81208



19307

# RICAMBI UNION SPECIAL

54400H,J		9-needle 16(1/4")gauge		
				
54420-9-16 Presser foot	54224A-9-16 Throat plate	54205A-9-16 Feed dog	59218-9-16 (54418-9-16) Needle holder	54242B-9-16 Retainer holder
54400H,J		12-needle 12(3/16")gauge		
				
54420-12-12 Presser foot	54224A-12-12 Throat plate	54205A-12-12 Feed dog	52918-12-12 (54418-12-12) Needle holder	54242B-12-12 Retainer holder
54200		4-needle UNEQUAL SPALE 1/4"-1"-1/4" gauge		
				
54220A-16-64-16 Presser foot	54224A-16-64-16 Throat plate	54205A-16-64-16 Feed dog	16154-16-64-16 Needle holder	54242B-16-64-16 Retainer holder
54200		4-needle EQUAL SPACINGS		
				
54220A-4-16 54220A-4-21 54220A-4-24 54220A-4-32 Presser foot	54224A-4-16 54224A-4-21 54224A-4-24 54224A-4-32 Throat plate	54205A-4-16 54205A-4-21 54205A-4-24 54205A-4-32 Feed dog	54218-4-16 54218-4-21 54218-4-24 54218-4-32 Needle holder	54242B-4-16 54242B-4-21 54242B-4-24 54242B-4-32 Retainer holder
LOOPER HOLDER		THREAD EYELETS FOR 54200,54400		
				
54485A	54485	54485A-4-16	54158	54158A
				
		1068	54459B	
				
54458-9	54458A-9	54459A-9	54458B-9	54458-12
				
		54458A-12	54459A-12	54458B-12
				
54492A	51292D	54459-12		
				
		54458C-9	54458C-12	16197-2-16
				
54491	51491C	16197-4-16 16197-4-21 16197-4-24 54458D-4-32		

# RICAMBI UNION SPECIAL

## PARTS FOR UNION SPECIAL

For 54200, 54400



54208A  
Looper



54208B  
Looper



54225  
Needle guard



54211A  
Retainer



54285C  
Nut



54244P  
Looper holder frame



51295A  
Mounting isolator



51817A  
Needle bar



51454B  
N.bar connection

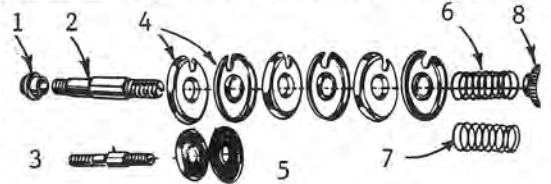

- 1 51292A Tension post ferrule
- 2 54492B Tension post
- 3 51292G Tension post
- 4 109(109D) Tension disc
- 5 54492 Tension disc
- 6 51292F-5 Tension spring
- 7 51292F-1 Tension spring
- 8 51292C Tension regulating nut

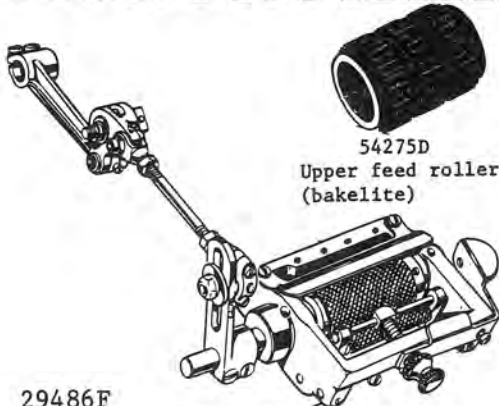

29486F  
Elastic metering device, complete



54275D  
Upper feed roller  
(bakelite)



54275E  
Upper feed roller  
(rubber)



54276  
Lower feed roller  
(bakelite)



54276A  
Lower feed roller  
(rubber)



54492C  
Tension post ferrule

### POPULAR SCREW FOR 54200, 54400



28C



73A



80



87



88



91



93



97A



98A



605A



22570A



22574



22585C



22596



22764A



22768



22845B



22848



22894P



J87J

### CORK GASKETS



52882P  
Crank chamber cover  
(upper) gasket



52882M  
Back cover gasket



51382A  
Oil reservoir  
top cover gasket



51282Z  
Face plate gasket

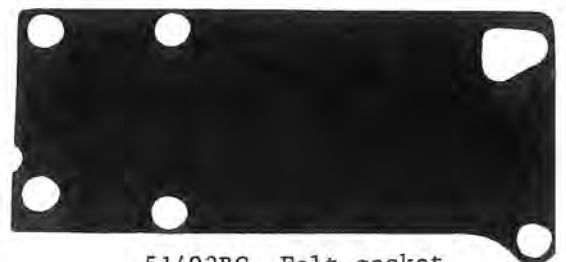

51493BG  
Felt gasket